



HAL
open science

Experimental Study of Supercritical CO₂ Heat Transfer in a Thermo-Electric Energy Storage Based on Rankine and Heat-Pump Cycles

Nicolas Tauveron, Edoardo Gino Macchi, Denis Nguyen, Thomas Tartière

► **To cite this version:**

Nicolas Tauveron, Edoardo Gino Macchi, Denis Nguyen, Thomas Tartière. Experimental Study of Supercritical CO₂ Heat Transfer in a Thermo-Electric Energy Storage Based on Rankine and Heat-Pump Cycles. Energy Procedia, 2017, 129, pp.939-946. 10.1016/j.egypro.2017.09.121 . hal-02915487

HAL Id: hal-02915487

<https://brgm.hal.science/hal-02915487v1>

Submitted on 6 Dec 2022

HAL is a multi-disciplinary open access archive for the deposit and dissemination of scientific research documents, whether they are published or not. The documents may come from teaching and research institutions in France or abroad, or from public or private research centers.

L'archive ouverte pluridisciplinaire **HAL**, est destinée au dépôt et à la diffusion de documents scientifiques de niveau recherche, publiés ou non, émanant des établissements d'enseignement et de recherche français ou étrangers, des laboratoires publics ou privés.



IV International Seminar on ORC Power Systems, ORC2017
13-15 September 2017, Milano, Italy

Experimental Study of Supercritical CO₂ Heat Transfer in a Thermo-Electric Energy Storage Based on Rankine and Heat-Pump Cycles

N. Tauveron^{a,*}, E. Macchi^b, D. Nguyen^c and T. Tartière^d

CEA, LITEN – DTBH/SBRT/LS2T, 17 rue des Martyrs Grenoble, 38054, France

IMFT, Université de Toulouse, 2 Allée du Professeur Camille Soula, 31400 Toulouse, France

BRGM Languedoc-Roussillon, 1039 rue de Pinville, 34000 Montpellier, France

Enertime, 1 rue du Moulin des Bruyères Courbevoie, 92400, France

Abstract

Multi-megawatt thermo-electric energy storage based on thermodynamic cycles is a promising alternative to PSH (Pumped-Storage Hydroelectricity) and CAES (Compressed Air Energy Storage) systems. The size and cost of the heat storage are the main drawbacks of this technology but using crystalline superficial bedrock as a heat reservoir could be a readily available and cheap solution. SELECO₂ research project considers a thermal doublet consisting in a “hot storage” in a bedrock and a cold storage in an ice pool. The complete system includes a heat pump transcritical CO₂ cycle as the charging process and a transcritical CO₂ cycle of 1 – 10 MWe as the discharging process. Various technical studies are undertaken to assess the performance of such system. Steady-state thermodynamic models have been realized to optimize system efficiency. In addition, unsteady models of geothermal heat exchanger network were developed for the ground heat storage. An experimental device has been designed and built to test the heat-exchange performance and dynamics. The conditions are intended to reproduce real process dynamics at a laboratory scale. The heat exchanger is at 1/10e scale with a 1.6 m height and 40 mm inner diameter. Temperature (40–130°C) and pressure conditions (~8–12MPa) follow the operating conditions of the real process coupled with a granitic bedrock. First results show that energetic and exergetic performances are better if a specific strategy of short charge and discharge cycles is employed rather than longer charge and discharge phases. Moreover experimental results will be used to improve the above-mentioned numerical simulations and to validate CFD simulations.

© 2017 The Authors. Published by Elsevier Ltd.

Peer-review under responsibility of the scientific committee of the IV International Seminar on ORC Power Systems.

* Corresponding author. Tel.: +33 4 38786151; fax: +33 4 38 78 51 61.

E-mail address: Nicolas.tauveron@cea.fr

1. Introduction

Thermo-electric energy storage (TEES) is a promising alternative to existing technologies that would allow widespread and large-scale electricity storage. It has a high energy density and is independent from geological or geographical constraints. During periods of excess electricity generation, a vapor compression heat pump consumes electricity and transfers heat between a low-temperature heat source and a higher temperature heat sink. The temperature difference between the heat sink and the heat source can be maintained for several hours, until a power cycle is used to discharge the system and generate electricity during peak consumption hours.

Mercangöz [1] gave references of thermo-electric energy storage studies as old as 1924 and described the general concept of this technology, based on two-way conversion of electricity to and from heat. He stated that the main challenges of TEES are to closely match the heat source and heat sink with the working fluid, and to find an optimum between roundtrip efficiency and capital cost. He analyzed a TEES system with transcritical CO₂, hot water and ice as storage materials. The ABB Corporate Research Center [2-3] described a way to store electricity using two hot water tanks, ice storage and transcritical CO₂ cycles. For similar systems, Morandin [4-5] defined a design methodology based on pinch analysis and calculated a 60% maximum roundtrip efficiency with turbomachinery efficiencies given by manufacturers.

Sensible heat storage with hot water tanks is often considered, since water has high thermal capacity, is very cheap and environmental-friendly. The heat sink of the system can be either the ambient or ice. This second option ensures a constant low-pressure for the process that is favorable to turbomachines.

Different working fluids can be considered for the cycles. Desrues [6] presented a TEES process based on Argon in forward and backward closed Brayton cycles. Henchoz [7] analyzed the combination of solar thermal energy with TEES based on Ammonia cycles. Kim [8] reviewed current TEES systems and showed that using CO₂ cycles instead of Argon Brayton cycles leads to a higher roundtrip efficiency even if the required temperature difference between the heat storages is much smaller. He also proposed an isothermal storage system based on CO₂ cycles and liquid piston compressors/expanders. In parallel, underground thermal energy storage appears to be an attractive solution [9].

The scientific content of a new project of thermo-electric energy storage is exposed in section 2. An experimental set-up of a particular part of the system has been built and is presented in section 3.1 Sections 3.2 and 3.3 are devoted to first results.

2. Thermodynamic cycle description

The investigated electro-thermal energy storage system is a massive storage concept studied by a French consortium (<http://seleco2.free.fr/>). The project considers a thermal doublet consisting in a “hot storage” in a crystalline superficial bedrock (e.g. granite) and a cold storage in an ice pool or ambient air. It also includes two thermodynamic cycles both using carbon dioxide as a working fluid.

During the off-hours (Figure 1-a)), the charging process consists of a transcritical heat pump cycle characterized by 6 main steps: the working fluid leaves the cold reservoir heat exchanger as a saturated vapour at $T_1 = T_{\text{cold}} - \Delta T_{\text{min}}$ and is internally superheated (1 → 2) through a regenerator with a 5K pinch, before being adiabatically compressed (2 → 3) with a mechanical compressor with isentropic efficiency of 0,85. At the compressor outlet, the fluid at $T_3 = (T_{\text{hot}})_{\text{max}} + \Delta T_{\text{min}}$ and supercritical high pressure P_3 is first cooled through the hot reservoir exchangers (3 → 4) releasing heat to the ground, then subcooled through the regenerator (4 → 5) releasing heat to the first flow. The fluid at a liquid state passes into an expansion valve (5 → 6) to reach the low pressure and is evaporated through the cold reservoir exchanger (6 → 1). An additional and small chiller system is used to cool down the fluid to the cold temperature.

During the peak-hours (Figure 1-b)), the discharging process consists of a transcritical Rankine cycle characterized by 6 main steps: the working fluid leaves the cold reservoir heat exchanger as a saturated liquid at $T_1' = T_{\text{cold}} + \Delta T_{\text{min}}$ and is adiabatically compressed (1 → 2) in a feed pump with isentropic efficiency of 0,8. At the outlet of the pump, the fluid at a supercritical high pressure P_2' is first preheated through the regenerator (2 → 3) with a 5K pinch, then heated further through the hot reservoir exchanger (3 → 4) destocking heat from the ground. At the entrance of the turbine, the fluid at a defined temperature $T_4' = (T_{\text{hot}})_{\text{max}} - \Delta T_{\text{min}}$ is adiabatically expanded (4

→ 5) to the low pressure delivering a mechanical work with isentropic efficiency of 0,9. Finally, the fluid is cooled in the regenerator (5 → 6) before being condensed through the cold reservoir exchanger (6 → 1). The component efficiencies including the generator and the rotary machines are fixed at commonly used values at nominal conditions [10]. Moreover specific design works on turbine and compressor were performed by Enertime; they mainly confirm the postulated performances. Detailed results and references can also be found in [10].

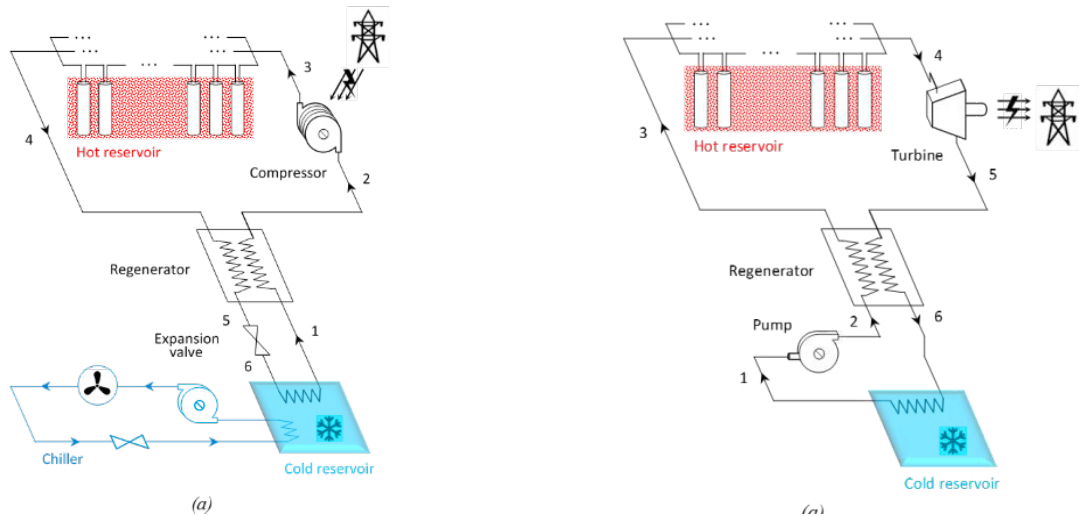

Figure 1: a) Charging process, b) Discharging process

3. Experimental set-up

3.1. Description

An experimental set-up has been built in order to investigate geothermal heat exchanger behavior. The experimental test loop constructed for the present study is schematically introduced in Figure 2. Only the main CO₂ circuit is detailed in this picture; for clarity reasons, cold water and hot oil circuits are just mentioned. The main CO₂ circuit is composed of a liquid CO₂ pump, a supercritical heater, the test sections, two absolute pressure transducer, a differential transducer, a pressure regulator, a condenser, a CO₂ tank, a subcooler, a flow meter and various thermocouples.

The test loop is filled with CO₂ with purity of 99.5%. Liquid CO₂ is circulated and compressed by a three head diaphragm pump (model LEWA ECOFLOW LDC3) which allows independent controls of discharge pressure and mass flow rate.

The fluid passes through the pre-heater (5 kW hot oil heating exchanger) to adjust the temperature at the inlet of the test section. After entering the expansion valve (pressure regulator in Figure 2), the pressure is lower than the critical pressure, and the fluid is condensed (5 kW cold water exchanger), stored in the CO₂ tank (connected to a 2 kW cold water cooling loop) and subcooled (2 kW cold water cooling circuit) to increase its density and its viscosity and to avoid cavitation before circulated by the CO₂ pump.

As illustrated in Figure 2, there are two distinct test sections which can operate in parallel. They cannot operate simultaneously. Each section is a 1.6 m-long vertical heat exchanger (Figure 3) where CO₂ is injected at the top in a 40 mm diameter section. Both test sections have the same geometrical dimensions which approximately correspond to the industrial configuration at a scale of 1:10. The only difference between test sections is that the first is surrounded by granite cylinder that is heated or cooled, whereas the second that has no bedrock around it is heated with a controlled electrical system. This last test section also contains more internal temperature measurements (18 in the fluid; 7 at section wall) than the first (3 in the fluid; 6 at bedrock wall). The CO₂ flow pass during charge and discharge phases is exactly the same. During the discharge phase the heater delivers no heat to CO₂.

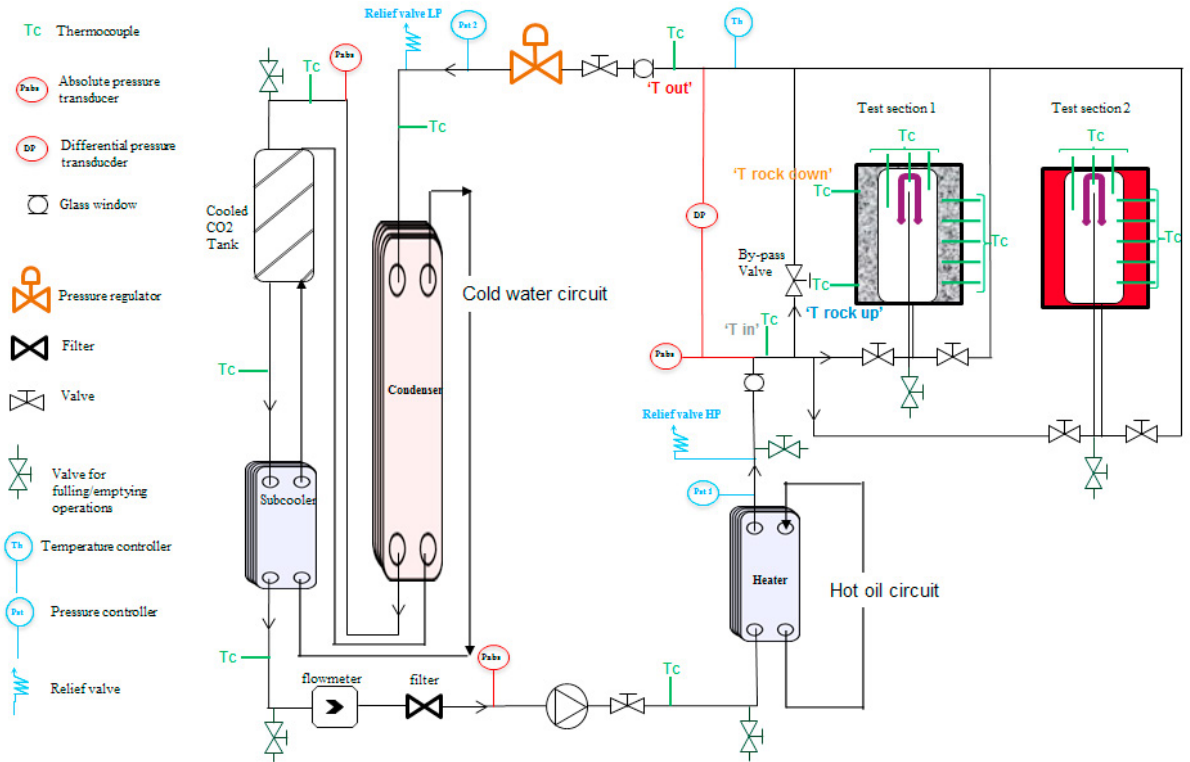

Figure 2. Schematic draw of CO₂ loop

The temperature in the loop and in the test section (CO₂, oil, water and granite) were measured using K-type thermocouples calibrated with an accuracy of 1.5 °C. Pressures were measured with uncertainties less than $\pm 0.15\%$. The mass flow rate of carbon dioxide was measured with an accuracy of 0.1% using a Coriolis mass flow meter.

3.2. First results on charge/discharge behaviour

The objectives of the tests are to experimentally validate the storage concept and to provide experimental data for the validation of the numerical models. Despite both section have been insulated, it seems that the heat losses are not negligible and consequently the temperature differences are larger than in the industrial configuration. In this section we present some results on charge/discharge behaviour. We have investigated experimentally two strategies for charging/discharging process.

3.2.1 Long charge and discharge

The first “natural” strategy is to have a “long” charge and discharge. The evolution of CO₂ temperature in at inlet and outlet of the test section is shown in Figure 8. The inlet condition is rapidly established whereas the outlet has a larger characteristic time. The evolution of rock temperature is also presented: during charge the rock temperature at the bottom of the test section is higher (located near the fluid inlet) than temperature at the top (located near the fluid outlet) while it is the opposite during discharge.



Figure 3. Photographs of CO2 loop and two vertical test sections

When the discharging process begins there is an abrupt change of CO₂ inlet temperature but the rock temperatures continue to increase during the first minutes of the discharging process due to the thermal inertia of the rock. Using inlet and outlet temperatures it is possible, knowing flow rate and pressure, to calculate an instantaneous power balance (Figure 4). Some “irregularities” can be explained by changes of the flow rate due to cavitation

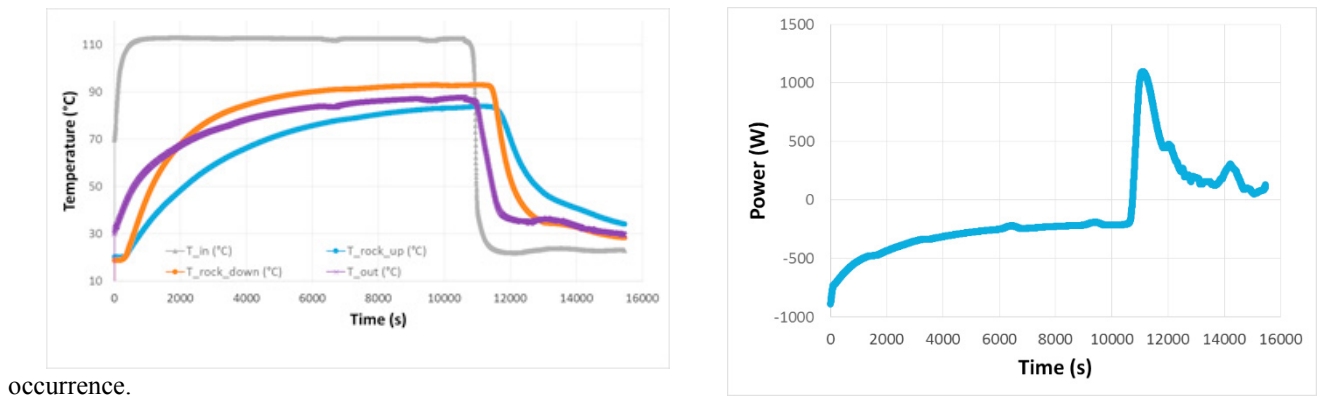

Figure 4. Evolution of temperature (left) and heat rate (right). Locations of thermocouples are mentioned in Fig. 2.

Integrating over time we can compute the cumulated energy during the charge and during the discharge (Figure 5); at the beginning of each phase integral is set to zero. A balance between the two processes can be also performed: the cumulated energy differences between charge and discharge can be explained by losses and “too short” recovery time. Regarding exergy, the efficiency is very low (16%). These small values encourage us to investigate another strategy.

Exergy (Ex) efficiency is defined as follows: $\eta_{ex} = (Ex_{out} - Ex_{in})_{discharge} / (Ex_{in} - Ex_{out})_{charge}$

3.2.2 Short charge and discharge

The second strategy consists in performing a first long charge and then shorter charge and discharge cycles. These shorter cycles of charge and discharge constitute the “active part” of the process: balances of energy and exergy are calculated on these sequences only. A longer discharging process can also occur at the end. The trends of fluid and rock temperatures during the first long charge are similar to the ones described in the previous paragraph. The same qualitative behavior can be seen in the short charge/discharge cycles. We notice that in the first

discharging process the temperatures are higher; the next cycles seem to be approximately similar. These trends can be also seen in the instantaneous power balance (Figure 6). When the power change its sign energy and exergy are

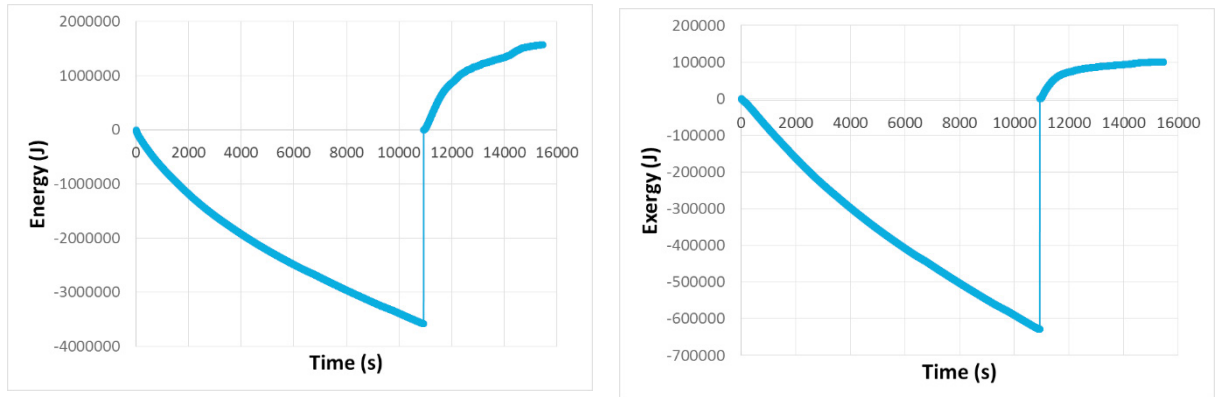

set to zero.

Figure 5. Evolution of cumulated energy (left) and exergy (right)

Cumulated energy and exergy during one charge and one discharge can be calculated; at the beginning of each phase integral is set to zero. They show higher recovery values (Figure 7) than in previous section: 68% instead of 44% for energy; 24% instead of 16% for exergy.

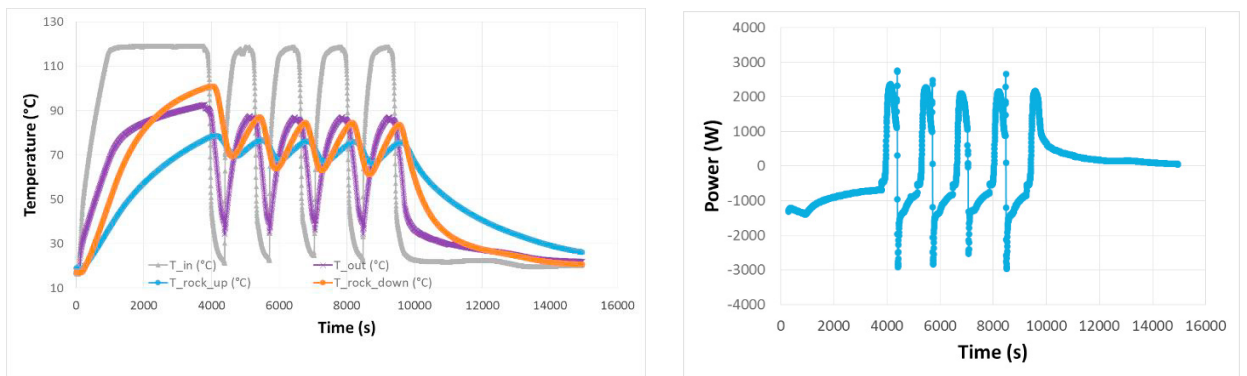

Figure 6. Evolution of temperature (left) and heat rate (right). Locations of thermocouples are mentioned in Figure 2.

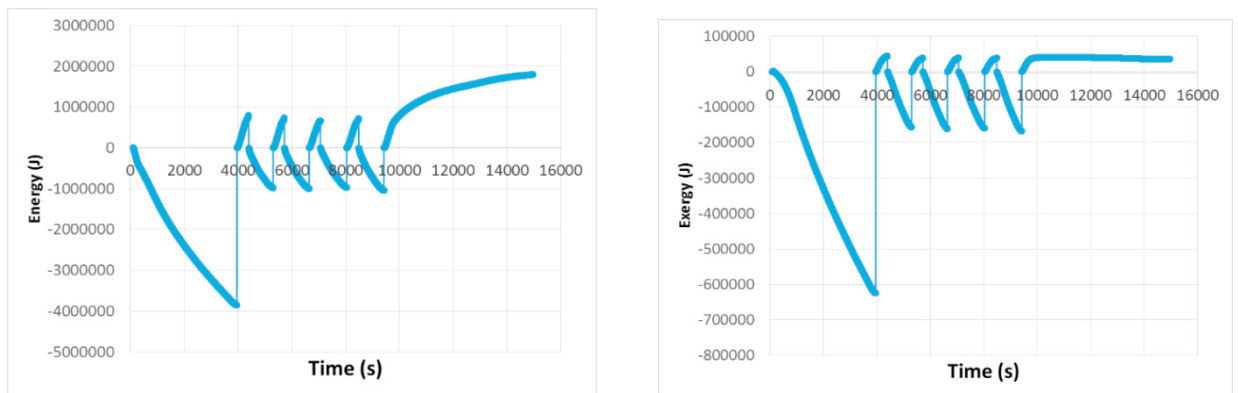

Figure 7. Evolution of cumulated energy (left) and exergy (right)

3.3. First results on heat transfer

Preliminary results are presented in Figure 8. The experimental data is based on experiments performed at various supercritical conditions: pressures (8 to 11 MPa), inlet temperatures (40 to 60°C), outlet temperatures (55 to 105°C) and mass flow rates (12 to 20 g/s). Nusselt numbers obtained vary between 50 to 100. Cross-comparisons with different correlations obtained on circular pipes at supercritical conditions were made (Jackson 2002: [11], Kirillov: [12], Fewster: [13]). Some differences between experimental results and correlations can be explained since experimental conditions are outside of the strict validity region of correlations. We can also mention noticeable differences between correlations. In addition some differences between experimental results and correlations might be due to our particular configuration.

From a physical point of view the convection regime is mainly dominated by free convection. Evaluations of non-dimensional parameter $Gr/Re^{2.7}$ give values between 0.0007 and 0.015 (Gr and Re and respectively Grashof and Reynolds numbers as defined in [14]), which corresponds to mixed and free convection [14]. A convenient way to present heat transfer results in such conditions is to consider the ratio between experimental Nusselt number and Nusselt number obtained in forced convection. This last number is generally expressed using Jackson 1975 correlation [15]. Figure 9 shows the ratios obtained with our experimental values. Additional curves are recommended correlations for mixed convection suggested by Jackson and Hall [14].

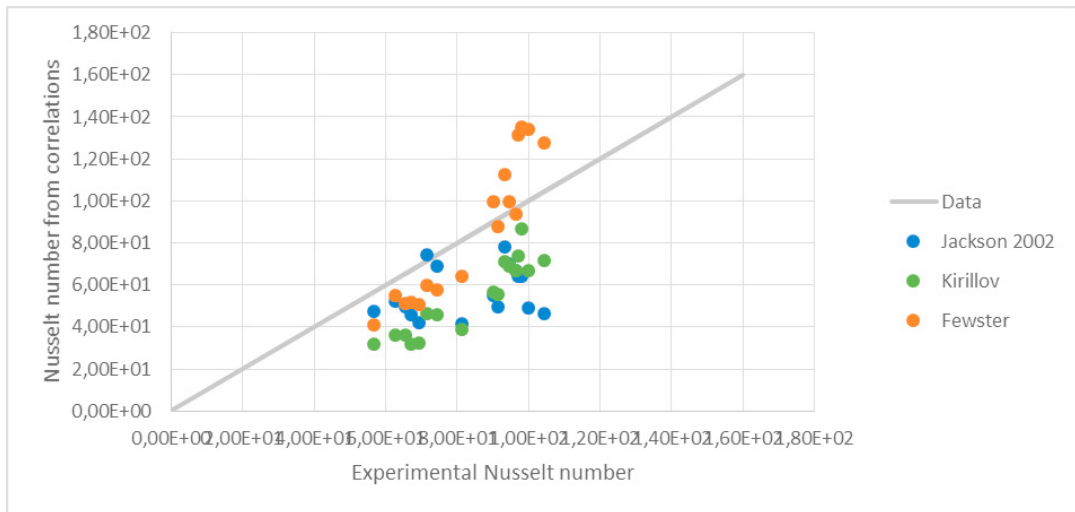

Figure 8. Nusselt number from different correlations vs experimental Nusselt number

Conclusion

The aim of this work is to assess the performance of a massive electricity storage involving CO₂ transcritical cycles and using the ground as a heat reservoir. An experimental device has been designed and built to test the heat-exchange performance of the hot storage and dynamics. The conditions are intended to reproduce real process dynamics at a laboratory scale. Temperature (40-130°C) and pressure conditions (~8-12MPa) follow the operating conditions of the real process. First results show that energetic and exergetic performances are better if a specific strategy of short charge and discharge cycles is employed rather than longer charge and discharge phases. Preliminary results were obtained on a dedicated test section with controlled heat flux. The regime is mainly dominated by free convection. The experimental data have been compared with traditional correlations. The experimental work is in progress. It will also provide temperature measurements in the hot storage in order to validate simulations. The numerical work, which concern transient simulations of the complete storage system, is detailed in [16]. It shows round trip efficiency of approximately 30-35% due to losses in storage and irreversibilities occurring in heat exchangers and machineries. The inclusion of such system within a heating or cooling network could also be an interesting use of the technology.

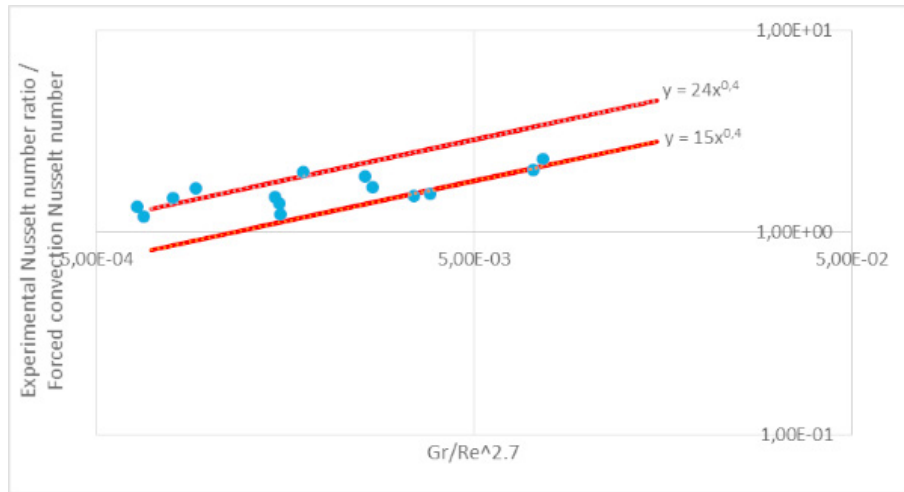

Figure 9. Nusselt number ratios vs $Gr/Re^{2.7}$

Acknowledgements

The authors acknowledge the support of Agence Nationale de la Recherche (ANR), under grant ANR-13-SEED-0004 (project SELECO2) and all participants of the project (ENGIE, IMFT, BRGM, CEA, ENERTIME).

References

- [1] Mercangöz M, et al., 2012. Electrothermal energy storage with transcritical CO₂ cycles, 407–415.
- [2] Hemrle J., Kaufmann L., Mercangoez M. Thermoelectric energy storage system having two thermal baths and method for storing thermoelectric energy. Patent EP2241737
- [3] Hemrle J., Mercangoez M., Ohler C, Thermoelectric energy storage system and method for storing thermoelectric energy. Patent EP2182179.
- [4] Morandin M, et al., 2012. Conceptual design of a thermo-electrical energy storage system based on heat integration of thermodynamic cycles. Energy, 375–396.
- [5] Morandin M, et al., 2013. Thermoeconomic design optimization of a thermo-electric energy storage system based on transcritical CO₂ cycles, Energy, 571–587.
- [6] Desrues T, Ruer J, Marty P, Fourmigué JF. A thermal energy storage process for large scale electric applications. Applied Thermal Engineering 2010;30(5):425-32.
- [7] Henchoz S, Buchter F, Favrat D, Morandin M, Mercangoez M. Thermoeconomic analysis of a solar enhanced energy storage concept based on thermodynamic cycles. Energy 2012;45(1):358e65.
- [8] Kim YM, Shin DG, Lee SY, Favrat D. Isothermal transcritical CO₂ cycles with TES (thermal energy storage) for electricity storage. Energy 2013; 49: 484–501.
- [9] S. Laninia, F. Delaleux, X. Py, R. Olivès, D. Nguyen, Improvement of borehole thermal energy storage design based on experimental and modelling results, Energy and Buildings 77 (2014) 393–400.
- [10] Ayachi F, et al. 2016, Thermo-Electric Energy Storage involving CO₂ transcritical cycles and ground heat storage, Applied Thermal Engineering, 1418-1428.
- [11] J.D. Jackson, Consideration of the heat transfer properties of supercritical pressure water in connection with the cooling of advanced nuclear reactors, In: Proceedings of the 13th Pacific Basin Nuclear Conference, Shenzhen City, China, October 21-25.
- [12] Igor L. Pioro, Hussam F. Khartabil, Romney B. Duffey, Heat transfer to supercritical fluids flowing in channels—empirical correlations (survey), Nuclear Engineering and Design, Volume 230, Issues 1–3, May 2004, Pages 69-91.
- [13] J. Fewster, Mixed convection and free convective heat transfer to supercritical pressure fluids flowing in vertical tubes, Ph.D. Thesis, University of Manchester, 1976.
- [14] A. Bruch, A. Bontemps, S. Colasson, Experimental investigation of heat transfer of supercritical carbon dioxide flowing in a cooled vertical tube, International Journal of Heat and Mass Transfer, Volume 52, Issues 11–12, May 2009, Pages 2589-2598.
- [15] J.D. Jackson, W.B. Hall, J. Fewster, A. Watson, M.J. Watts, Heat transfer to supercritical fluids, U.K.A.E.A. A.E.R.E.-R, Report 34, 1975.
- [16] Macchi, E.G. et al. (2016), Thermoelectric energy storage based on CO₂ transcritical cycles: ground heat storage modelling, 1st European Seminar on Supercritical CO₂ Power Systems, September 2016, Vienna, Austria.