



HAL
open science

CEReS -Co-processing of Coal Mine & Electronic Wastes: Novel Resources for a Sustainable Future

Christopher G. Bryan, B J Williamson, J Calus-Moszko, Q van Haute,
Anne-Gwenaelle Guezennec, S Gaydardzhiev, P Wavrer, R Frączek

► To cite this version:

Christopher G. Bryan, B J Williamson, J Calus-Moszko, Q van Haute, Anne-Gwenaelle Guezennec, et al.. CEReS -Co-processing of Coal Mine & Electronic Wastes: Novel Resources for a Sustainable Future. International Biohydrometallurgy Symposium - IBS 2019, Oct 2019, Fukuoka, Japan. hal-02164802

HAL Id: hal-02164802

<https://brgm.hal.science/hal-02164802>

Submitted on 12 Dec 2019

HAL is a multi-disciplinary open access archive for the deposit and dissemination of scientific research documents, whether they are published or not. The documents may come from teaching and research institutions in France or abroad, or from public or private research centers.

L'archive ouverte pluridisciplinaire **HAL**, est destinée au dépôt et à la diffusion de documents scientifiques de niveau recherche, publiés ou non, émanant des établissements d'enseignement et de recherche français ou étrangers, des laboratoires publics ou privés.



CEReS
Novel Resources for a Sustainable Future

International Biohydrometallurgy Symposium

23rd October, 2019
Fukuoka, Japan

CEReS: Co-processing of Coal Mine and Electronic Wastes

Dr Chris BRYAN

Geomicrobiology and Environmental Monitoring unit (GME), BRGM, France



This project has received funding from the Research Fund for Coal and Steel under grant agreement No 709868



Industrial Ecology & Symbiosis

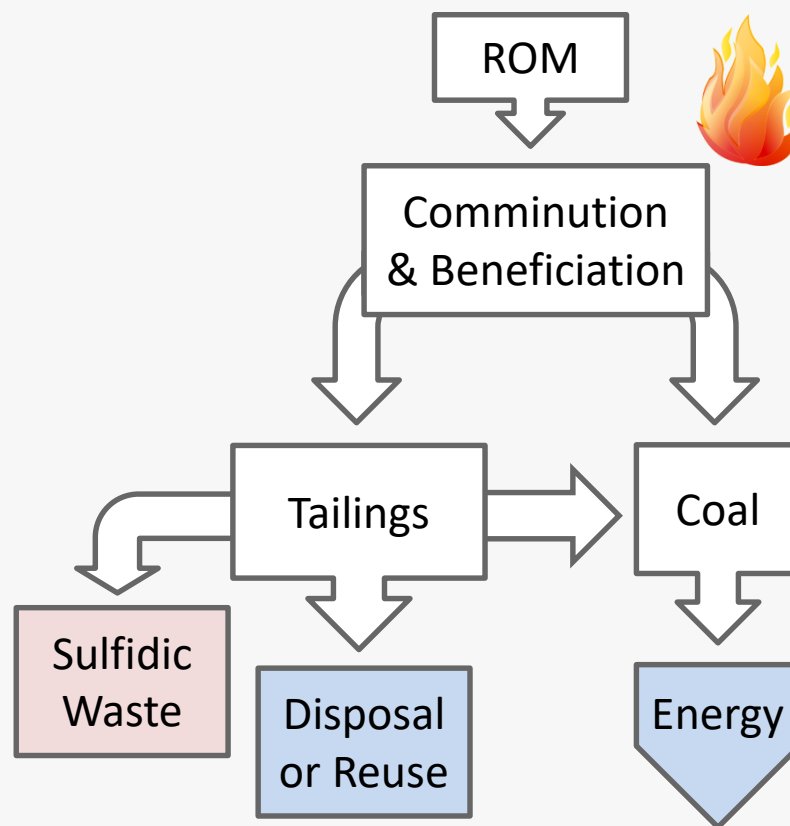
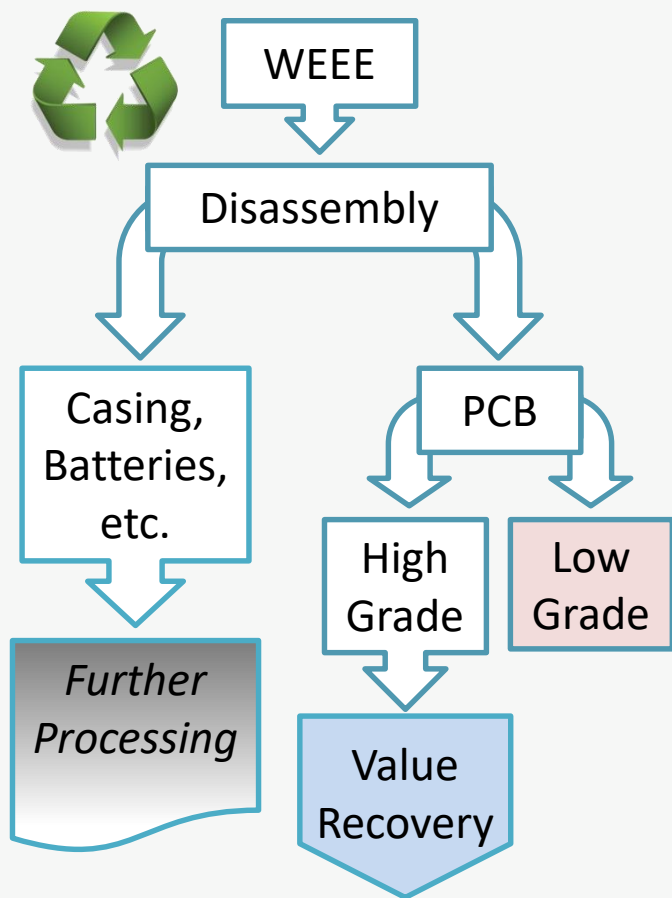

Integrated Process

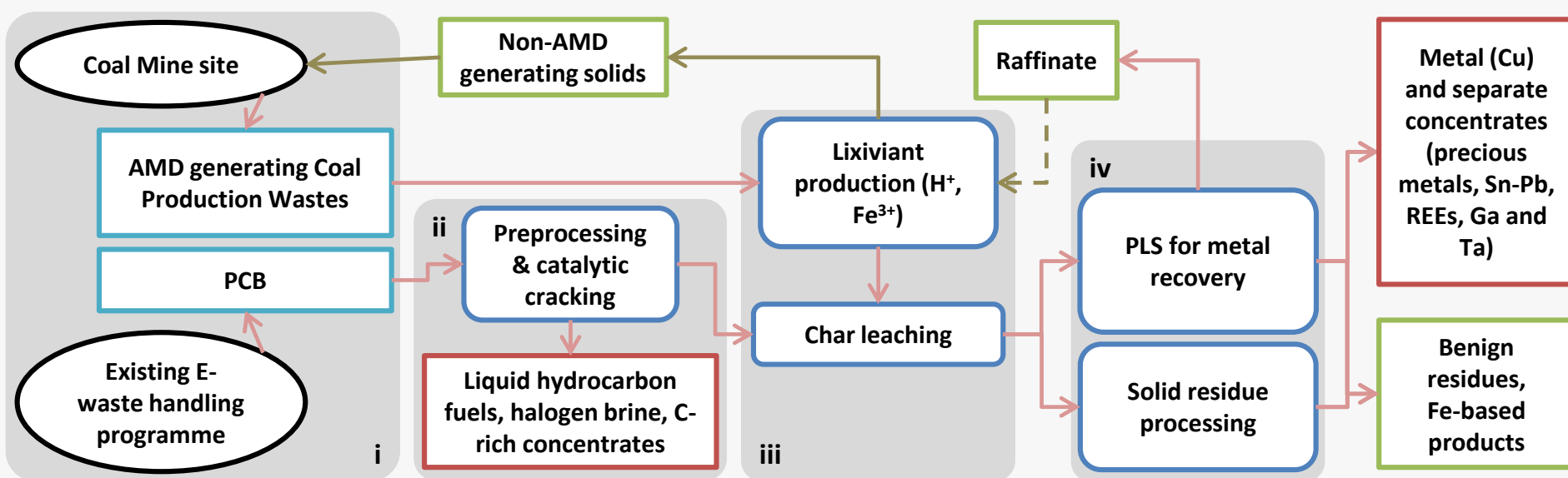

Key Details

- Received funding from the Research Fund for Coal and Steel (RFCS)
- Three-year R&D project from June 2016; project budget ~3.2M€
- Eight partners from five countries
 - University of Exeter (Coordinator) UK
 - BRGM; Caspeo FR
 - Université de Liège; Comet Traitements BE
 - GIG; TAURON Wydobycie PL
 - University of Cape Town RSA

Key Details

- Use Poland as case study region
- Prove technical feasibility of individual unit processes
 - At (mini) pilot-scale
- Integrate through modelling and simulation
 - Demonstrate viability of concept
 - Include economic assessment
- Evaluate environmental benefit vs “do nothing” scenario
 - LCA

Raw Materials

- Analysed four coal waste streams
 - Selected Janina Spiral Tails (~12% Py)
 - Detailed mineralogical characterisation
- Bioprospecting
 - Two bioleaching consortia (30°C & 48°C)
 - Microbial ecology of Janina waste dump (NGS)
- Characterised AMD-generating potential
 - “Missing Acid” question...

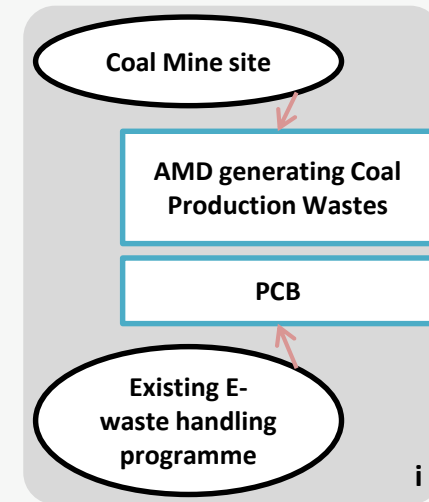

Raw Materials

- Analysed WEEE processing in Poland
 - Three PCB categories; selected low-grade
- Not as required; ~35% PCB
 - use Comet own stock
- Detailed characterisation & analysis
 - Metal/value breakdown
 - Au and PM highest values; Cu significant.
- Produced database and cross-map.

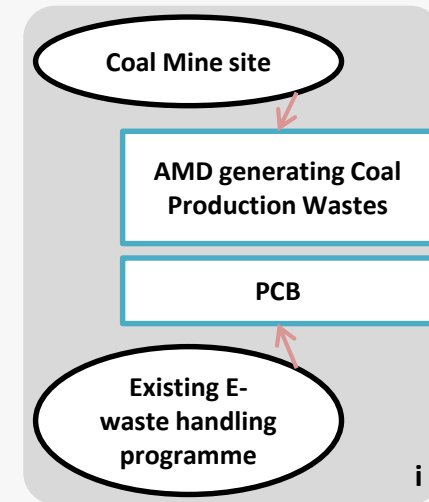

Catalytic Cracking

- Adaption of Comet's pyrolysis process to PCB
 - Initial orientative bench-scale tests
 - Pilot scale tests – Phoenix reactor
- Produced and characterised char and hydrocarbon outputs
 - **Hydrocarbon** – 18% original mass; requires removal of Si prior to use in co-generation engine
 - **Char** – four size categories: +8 mm; 2-8 mm; 75 µm-2 mm; -75 µm
 - **Bromine** – 74% recovered in quench water
- >90% Ag, Au and Cu concentrated in two fractions
 - ~47% input; concentration factor ~2

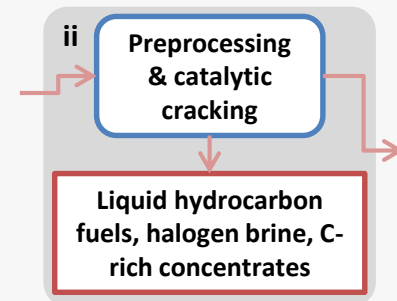

Cataly

-
-

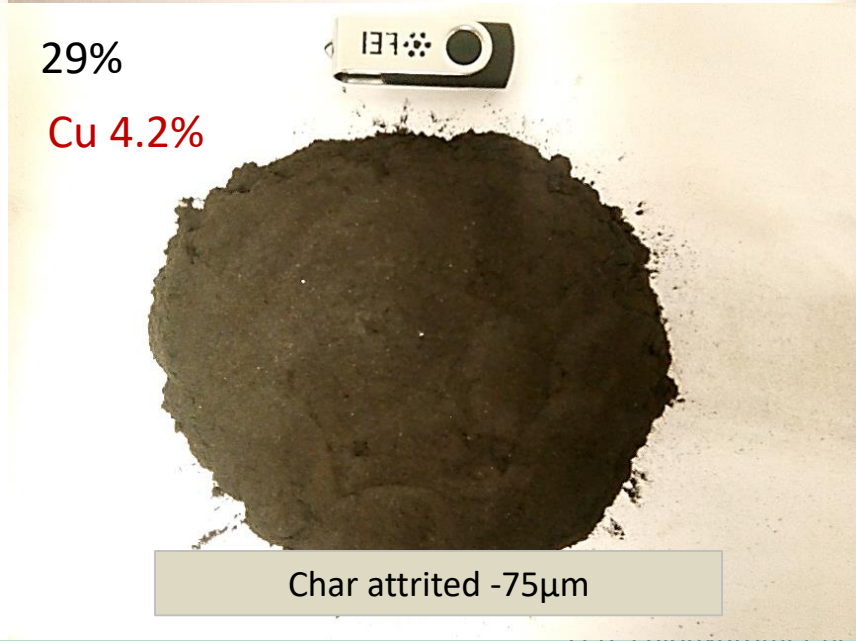
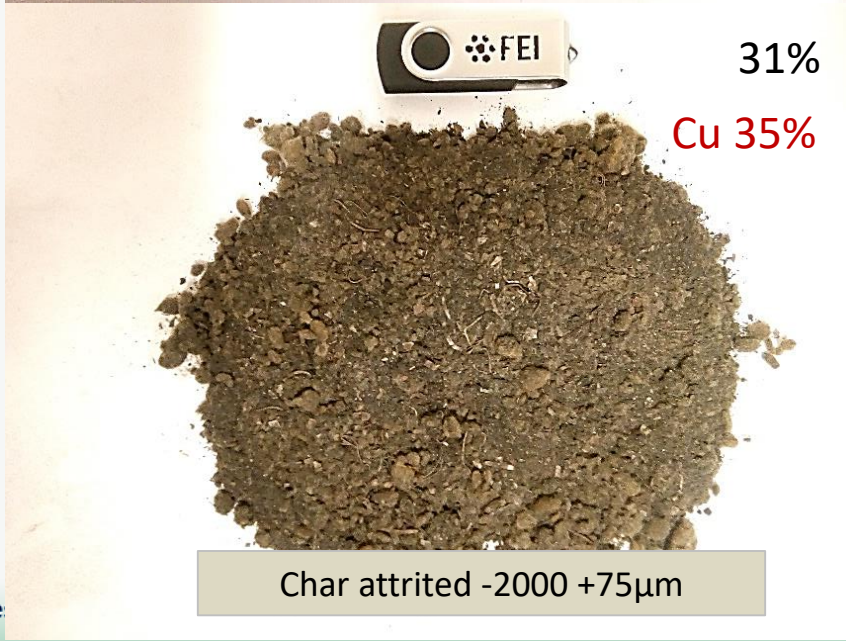

Coal Waste & Char Leaching

- Selection of bioleaching consortia
 - Two enriched from Janina waste, two existing bioleaching consortia
 - Selected 48°C “TW48” consortium from Janina waste
- Biolixiviant capable of leaching char
- Huge problem with corrosion
 - caused by Cl content of waste...
- Decide on appropriate strategy
 - washing or using different waste?

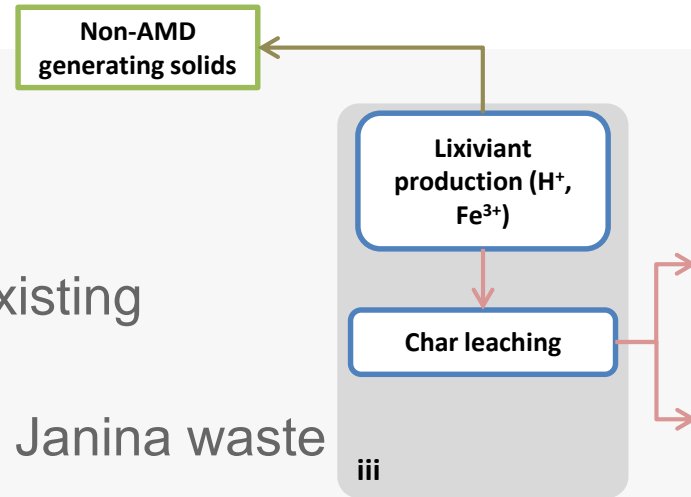

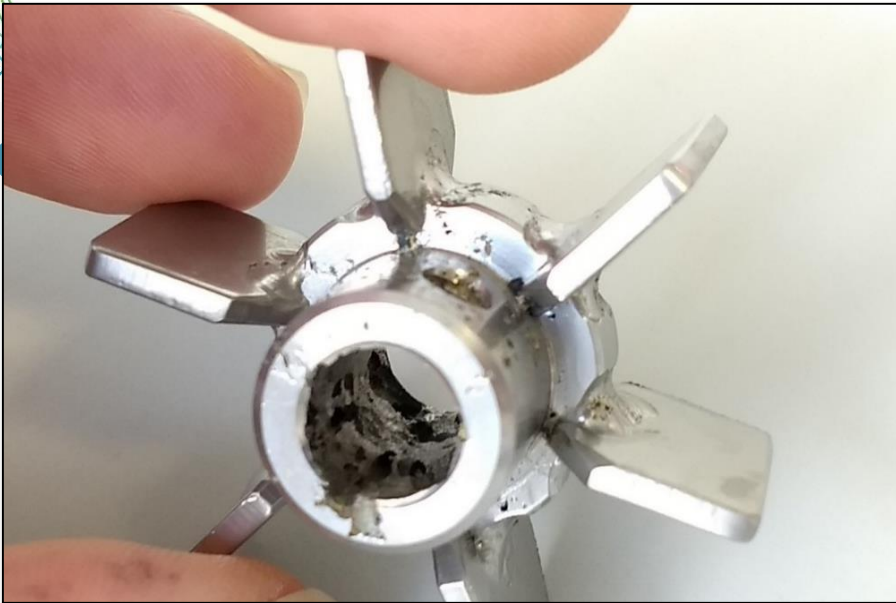

Non-AMD
generating solids

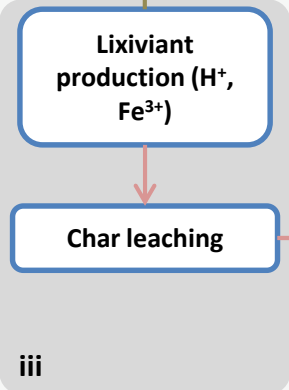

nsortia
aste, two existing
ortium from Janina waste



Coal Waste & Char Leaching

- Improved environmental stability of bioleached coal waste
- Geochemical modelling + Quantitative mineralogy to investigate “missing acid” phenomenon
 - Biokinetic AMD test provides useful additional information
- Potential issue of latent acidity...

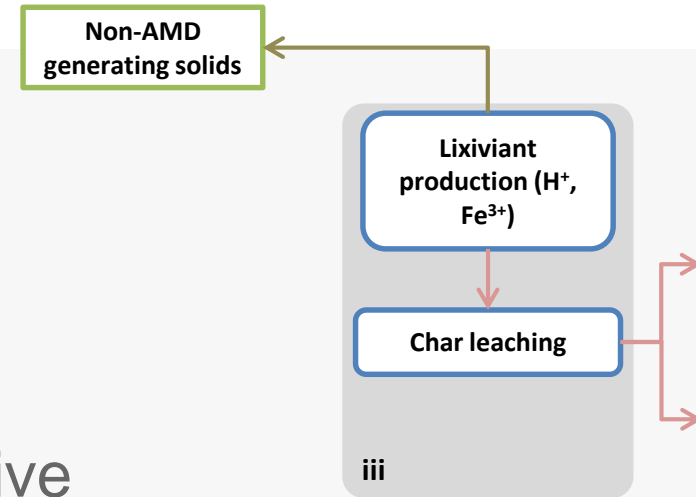

iii

Coal Waste & Char Leaching

- Possible reuse of fine-grained waste in production of **ceramic** products, **granulates**, **concrete** products

Non-AMD
generating solids

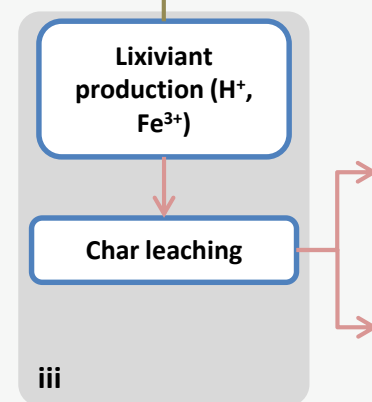

ceramic products

production of granulates

concrete products

polymerconcrete

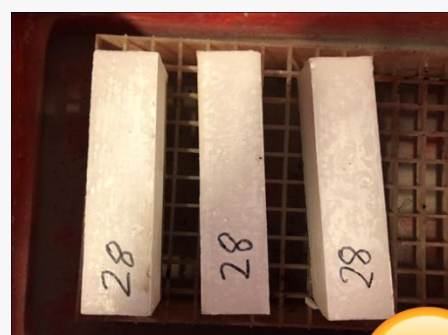

Coal Waste & Char Leaching

- Char leaching options tested
 - Reactor type, design, operating conditions
 - Char pre-processing
- Char leaching can result in 100% Cu dissolution
 - Colonisation of char leaching reactor possibly beneficial
 - Bi-phasic...

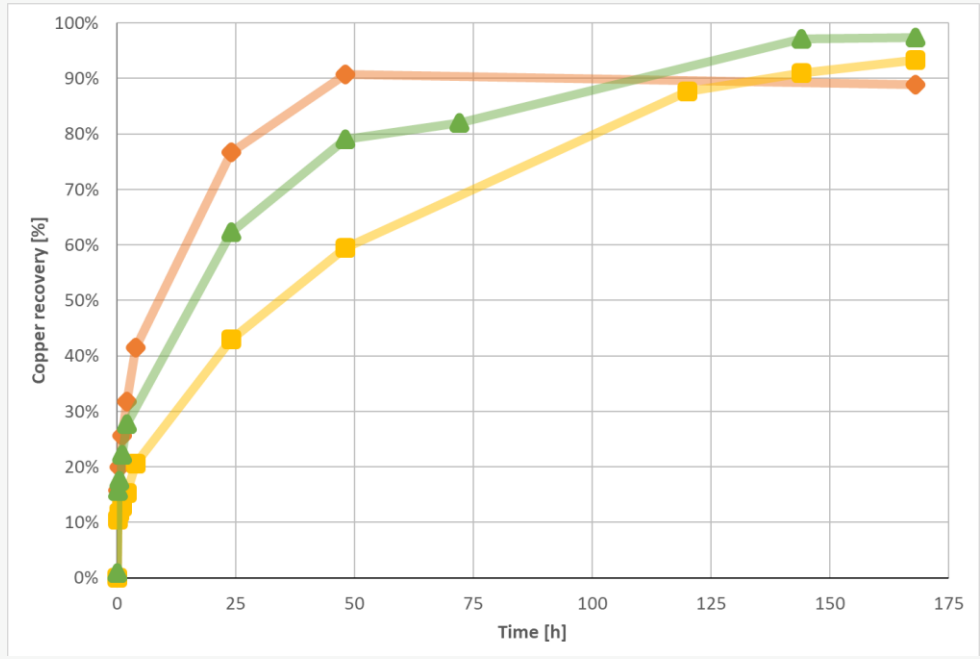
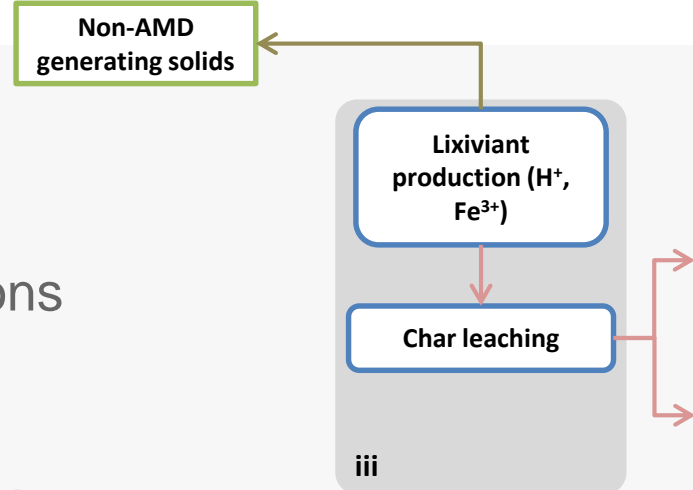

Refining of Products

- Selected Acorga for SX due to high selectivity
- Iron management possible via precipitation of jarosite and conversion to hematite
- Only able to valorise Cu within the scope of the project
 - Work required to recover PM

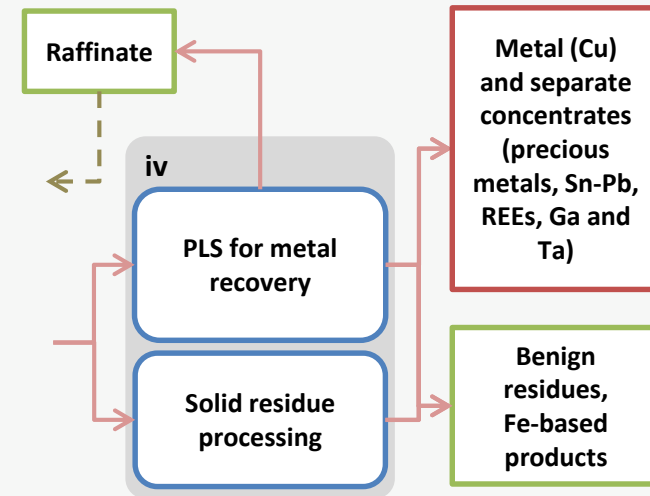

Process Integration

- Process simulator compiled in USIM PAC

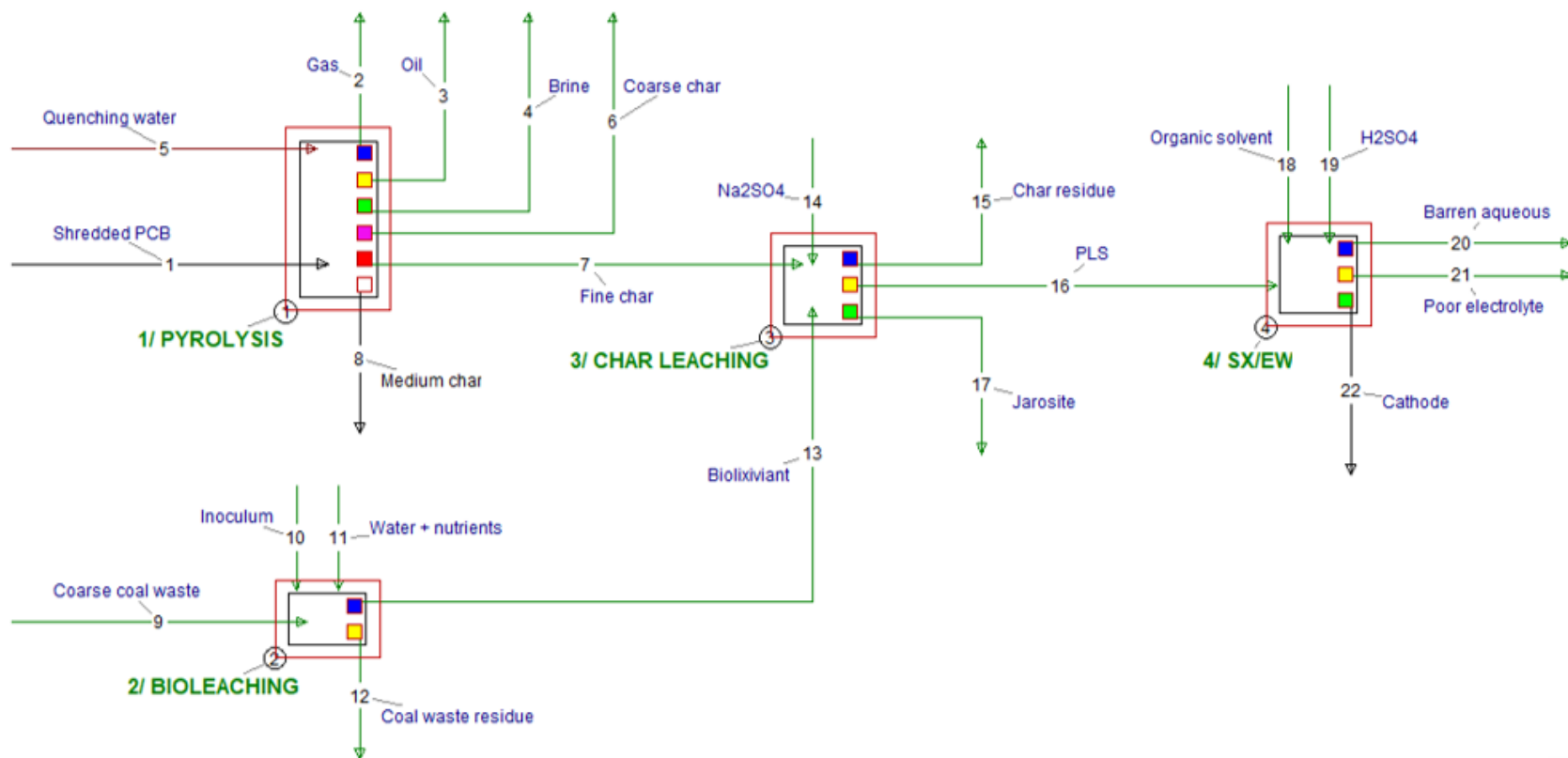
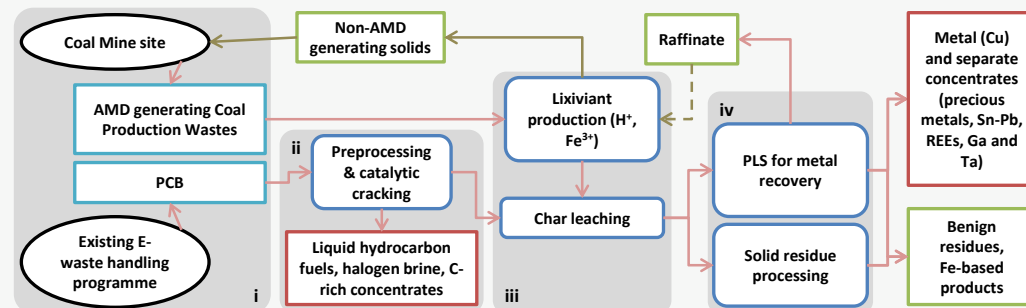

Process Integration

- Evaluate & compare different scenarios

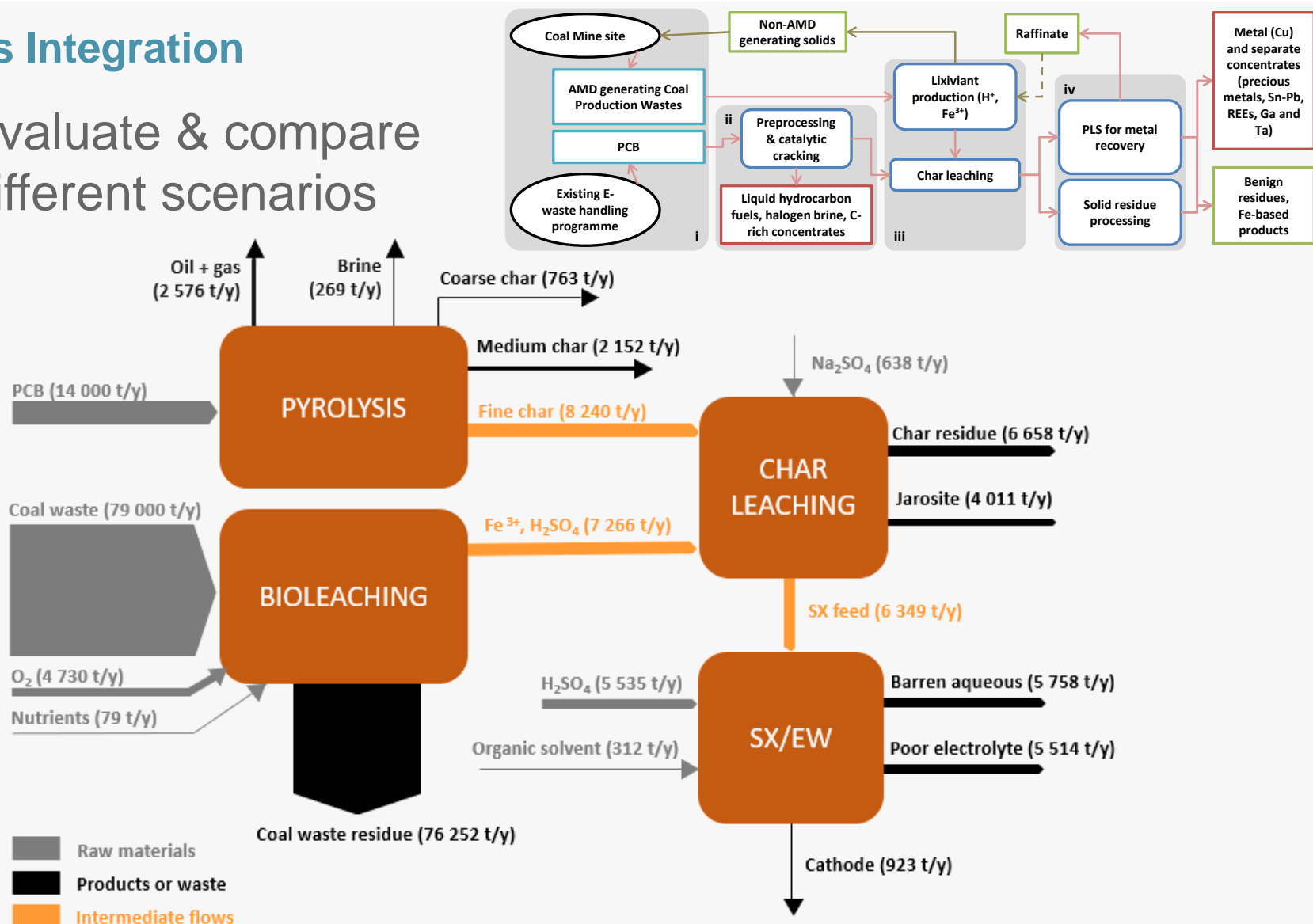

Process Integration

- CEReS does not make money *if...*

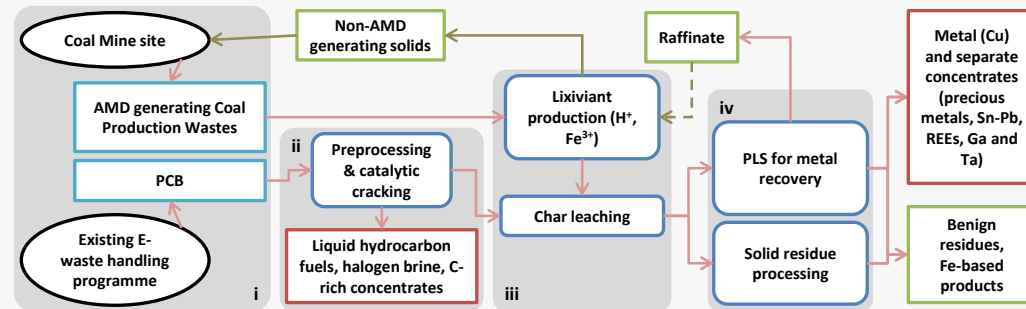

- Cost of PCBs based on market value (Umicore)
- Coal waste cost-neutral
- Stabilised (bioleached) coal waste has no value

BUT...

- LCA analysis shows significant benefit of CEReS process over the do nothing (business as usual) scenario (for majority of impact categories)



CEReS
Novel Resources for a Sustainable Future

International Biohydrometallurgy Symposium

23rd October, 2019
Fukuoka, Japan

ありがとう
Thank You, Merci, Dziękuję, Dankie

ceres.biohydromet.net



This project has received funding from the Research Fund for Coal and Steel under grant agreement No 709868

