



HAL
open science

An evaluation of ground thermal properties measure accuracy by thermal response test of horizontal ground heat exchangers

Mikael Philippe, Dominique Marchio, Hervé Lesueur, Alexandre Vrain

► To cite this version:

Mikael Philippe, Dominique Marchio, Hervé Lesueur, Alexandre Vrain. An evaluation of ground thermal properties measure accuracy by thermal response test of horizontal ground heat exchangers. World Geothermal Congress 2010, Apr 2010, Bali, Indonesia. 8 p. hal-00495034

HAL Id: hal-00495034

<https://brgm.hal.science/hal-00495034>

Submitted on 24 Jun 2010

HAL is a multi-disciplinary open access archive for the deposit and dissemination of scientific research documents, whether they are published or not. The documents may come from teaching and research institutions in France or abroad, or from public or private research centers.

L'archive ouverte pluridisciplinaire **HAL**, est destinée au dépôt et à la diffusion de documents scientifiques de niveau recherche, publiés ou non, émanant des établissements d'enseignement et de recherche français ou étrangers, des laboratoires publics ou privés.

An evaluation of ground thermal properties measure accuracy by thermal response test of horizontal ground heat exchangers

Mikael Philippe, Dominique Marchio, Hervé Lesueur and Alexandre Vrain

BRGM, 3 avenue Claude Guillemin, BP 36009, 45060 ORLEANS, FRANCE

M.Philippe@brgm.fr

Keywords: Horizontal ground heat exchanger, ground source heat pump, thermal response test

ABSTRACT

This study aims to present a comparison between temperature measurements relative to horizontal ground heat exchangers with predicted values using thermal response test. A scale 1 test facility of horizontal ground heat exchangers has been implemented in BRGM (Orleans - France) to test performances in real conditions. The heat exchanger is divided in four parts of 100 m² each with different characteristics:

- a sunny grass
- a shaded grass
- a sunny car-park
- a shaded car-park

These different configurations have been chosen to compare the performances of ground heat exchangers in different environments (surface state, boundary conditions). Furthermore, the temperature in the soil is measured continuously at 3 different levels (-0.5 m, -1 m, -1.5 m). To cartography the temperature field at these 3 depths, optical fibers are distributed in the underground and the use of a distributed temperature sensor (DTS) allows to accurately measure the temperature in the soil surrounding the ground heat exchanger.

A thermal response is carried out on the horizontal ground heat exchanger. A monitored constant heating power is injected at a constant mass flow. The temperature measurements at the 3 different levels of a three-dimensional numerical model of ground heat exchanger.

The thermal response test gives in particular the noticeable differences between the 4 different conditions of each part of the ground heat exchanger. The conclusion will give indications on the consequences of uncertainty about soil thermal properties on sizing.

1. INTRODUCTION

In the actual international context of global warming, it seems necessary to improve the knowledge of renewable energies. The geothermal heat pump technology is an interesting way to help us to considerably reduce the CO₂ emissions of the heating systems. In fact, the relatively stable temperature of the underground allows heat pump to operate with a very efficient coefficient of performance and to reduce considerably the electrical energy consumption. Some different types of underground heat exchangers are proposed for such heat pumps: horizontal or vertical ground heat exchangers, compact ground heat exchangers, etc. Horizontal ground heat exchangers are less efficient because of the variability of the soil temperature at such depths (generally around 1 m deep), but the present the advantage to be much cheaper than boreholes. The

performances of such systems, depending on the soil properties and the climatic conditions at the soil surface are not yet very well known.

This article aims to present first results of characterization of horizontal ground heat exchangers by thermal response tests. Thermal response tests are commonly used for vertical ground heat exchangers, generally in order to size a borehole thermal energy storage (BTES). Such tests are then analyzed and average values of thermal properties of the soil are obtained (Gehlin, 2002). Different types of thermal response test are carried out, short term or long term tests (Hellström, 2006).

Thermal response tests have been experimented on horizontal ground heat exchangers by Inalli and Esen (Inalli, 2004), the results of these experiments are used to validate a two dimensional numerical model (assuming conduction for only heat transfer mode) (Esen et al., 2007). In these experiments, the temperature of the underground was not measured. The underground heat exchangers were linked to a heat pump, the only measured temperatures of the heat exchanger were the fluid temperatures at the inlet and at the outlet (corresponding to the outlet and inlet of the evaporator of the heat pump).

In an only buried tube, Piechowski (Piechowski, 1998) also experimented some procedures of thermal response tests. The temperature was measured in the soil at different locations around the heat exchanger and allowed Piechowski to validate precisely a two dimensional model of heat and mass transfer in the underground.

A test facility has been implemented at the site of BRGM (French Geological Survey) in Orléans (France) to measure the performances of different types of ground heat exchangers and in particular, horizontal ground heat exchangers. The scientific objectives of this test facility are the following:

- Evaluate the influence of climatic parameters on the performance of horizontal ground heat exchangers (rainfall, sunshine, ...) and the effect of different type of soil surfacing (lawn, park area, ...)
- Determine the impact of varying thermal properties of soil along the depth on the efficiency of borehole heat exchangers
- Test and measure the performances of new types of ground heat exchangers

2. DESCRIPTION OF THE TEST FACILITY

The test facility implemented in Orléans is integrated in a grove of oak trees to show the good integration of such systems in the environment (see Figure 1).



Figure 1: Overview of the test facility

The thermodynamic machinery and the metrological devices are disposed in the three wood huts. The horizontal ground heat exchangers are implemented in a clearing, 1 m below the ground surface.

2.1 Implementation of the horizontal ground heat exchangers

The area of horizontal ground heat exchangers is divided in 4 distinct sectors of each 100 m² with different expositions and surface linings: a shaded lawn, a sunny lawn, a shaded car-park and a sunny car-park (see Figure 2). The soil is more compacted in the car park area, which has for effect a reduction of the soil porosity and consequently different potentials of evapotranspiration.



Figure 2: View of the 4 different sectors of horizontal ground heat exchangers

At the time of implementation of these horizontal ground heat exchangers at 1 m depth, the soil was excavated 2 m deep. The soil has been mixed before filling in order to have the same thermo-physical properties of soil around the heat exchangers

Each sector of 100 m² is equipped with two pipe loops of 100 m long each. The loops are then linked in parallel for the regulation of the system and only one of the two loops can be used for the experiments. The equipment of 1 sector by its two loops is presented in Figure 3.



Figure 3: Equipment of one horizontal ground heat exchanger sector by its 2 fluid loops at 1 m depth

The soil has been analyzed, it is an argillaceous sand with a few little pieces of flint.

2.2 Thermodynamic machinery and monitoring system

The thermodynamic machinery commands 5 circulation loops. Two of these loops are dedicated to the horizontal ground heat exchangers, the three others are used to feed the vertical and compact ground heat exchangers. The two circulation loops of the horizontal heat exchangers govern each two sectors of heat exchangers in parallel: the first loop for the “lawn” sectors and the second loop for the “car park” sectors.

The different control loops are visible on the monitoring window in Figure 5. All the loops are filled with an anti-freeze mixture of water and monopropylene glycol (60 % water).

The thermodynamic machinery can operate in two distinct modes: one to simulate the operation of a ground-source heat pump in winter (withdrawal of heat from the soil), the second for a ground source heat pump in summer (injection of heat in the soil). This machinery is setted in a dedicated wood hut (see in Figure 4).



Figure 4: Thermodynamic machinery implemented in the hut

A water tank of 750 L can store a volume of cold water in winter mode, and respectively hot water in summer mode. This tank is linked to a chiller of 78 kW for winter mode and to an electrical heater of 27 kW for summer mode (see at the left of Figure 5). For each control loop, an electrical heater of 3 kW can adjust the fluid temperature before entering into the ground.

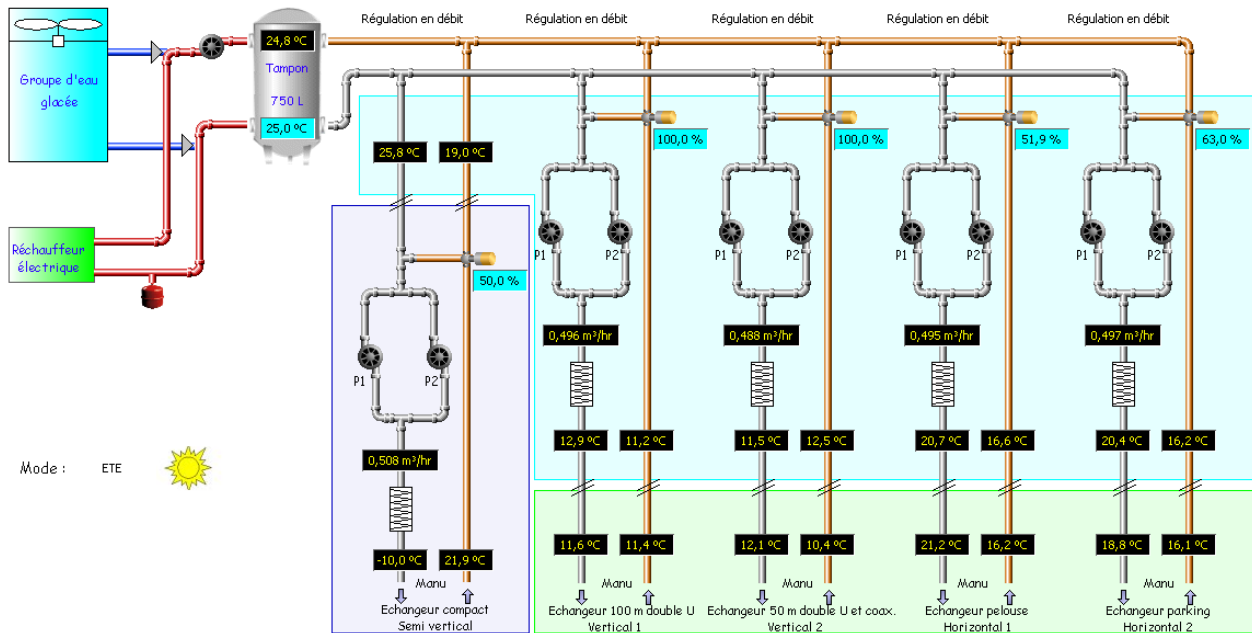

Figure 5: View of the monitoring window of the thermodynamic machinery

Each control loop is equipped with two feed pumps (P1 and P2 in) mounted in parallel (to facilitate the maintenance). A three way valve controls for each loop the mixed fluid proportions to reach the set point temperature at the inlet of the ground heat exchanger.

2.3 Temperature measurement in the underground

To obtain the temperature field around the horizontal ground heat exchangers, the principle of distributed temperature measurement is adopted for this test facility. This distributed temperature measure is carried out through optical fibers. An optical fiber is unrolled in the underground and it is then possible to obtain an average temperature value at each meter of optical fiber. This technology of temperature measurement has been already used for geothermal energy studies to measure the temperature evolution around borehole heat exchangers by Fujii (Fujii, 2009).

This measurement technique uses the physical phenomenon of Raman diffusion. After emitting a laser pulse, the distributed temperature sensor analyses the diffusive signal. The temperature is obtained as a function of the amplitude of the satellite lines “Raman”.The signal treatment giving temperature is implemented in a second hut where all the optical fibers come out from the soil (see Figure 6)

The measurement optical fibers are spread over three depth levels under the soil surface: -0,5 m, -1 m and -1.5 m.. The Figure 7 shows the implementation of the optical fibers at -1.5 m after excavation of the soil. The optical fibers are unrolled along the heat exchanger tube for the -1 m level and at the verticality of this exchanger tube for the two other levels (0.5 m above and below).



Figure 6: Measurement optical fibers and signal treatment implemented in the second hut



Figure 7: Implementation of the optical fibers at 1.5 m

2. A FIRST THERMAL RESPONSE TEST

The first test executed on the test facility is a short term thermal response test. For this test, four ground heat exchanger pipes of 100 m length are activated, one in each sector (shaded lawn, sunny lawn, shaded car-park and sunny car-park). The geometry and the dimensions of these loops, buried at 1 m depth are specified in Figure 8.

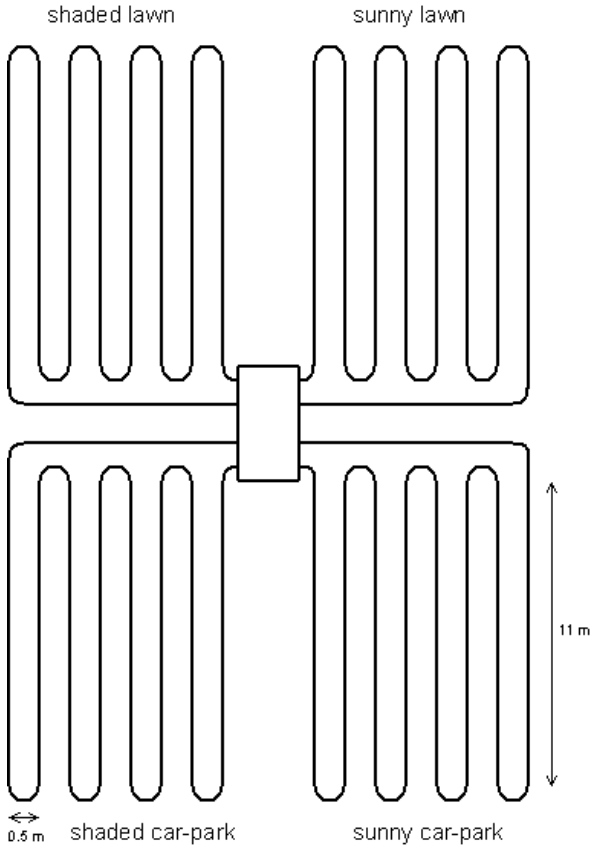

Figure 8: Arrangement of the four ground heat exchanger pipes

These four underground pipes are linked to two monitored loops (see in Figure 5). The two “car-park” pipes are linked in parallel to the first regulation loop. The two other pipes (“lawn”) are linked in parallel to the second regulation loop.

This test was carried out in Mai 2009 during 6 days. The outside air temperature during these 6 days is given in Figure 9. Only one rainfall was registered during the test, occurring the 3rd day with a level of 5.2 mm water.

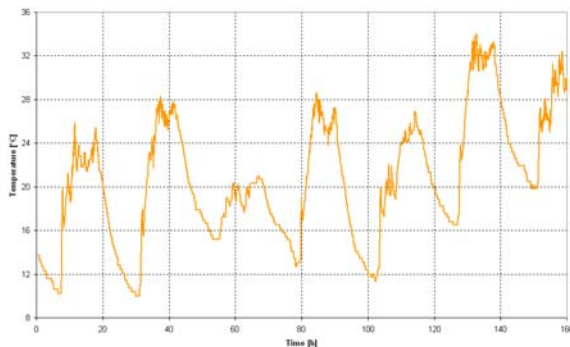

Figure 9: Outside air temperature during the tests

The thermodynamic machinery is in summer mode. It means that hot fluid is injected under the ground. The system is regulated in thermal power and mass flow.

The thermal power exchanged with the surrounding soil is equal to 10 W for each meter of ground heat exchanger pipe. This value corresponds to a value of 20 W/m². It is a typical sizing value according to the German guideline VDI4640 (see the sizing table in Figure 10).

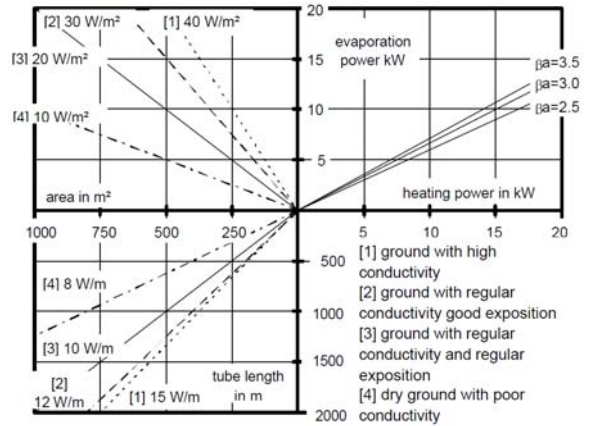

Figure 10: Table of sizing of horizontal ground heat exchangers extracted from the German guideline VDI4640

The mass flow imposed in the heat exchanger pipes is equal to 0.25 m³/h for each, which is a typical value recommended by some heat pump manufacturers for the ground heat exchanger loops linked to their residential ground source heat pumps.

Each regulation loop is linked to two ground heat exchanger pipes. It means that a thermal power of 2 kW is injected into the soil by each regulation loop. The Figure 11 shows the evolution of the injected heat powers in function of time. The regulation loop is quite accurate, only a deviation of 0.1 kW from the set point value is noticeable.

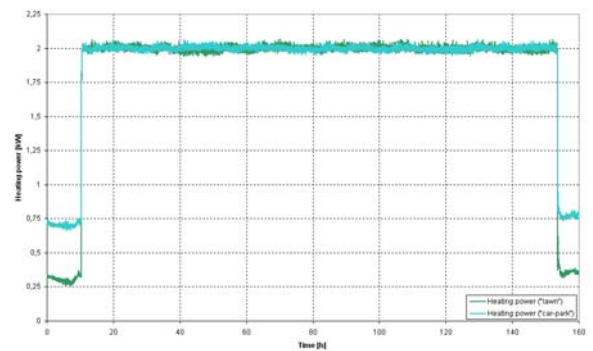

Figure 11: Thermal power injected in the soil by the two control loops during the 6 days thermal response test

Figure 12 presents the evolution of the temperatures at the inlet and outlets of two control loop of the ground heat exchangers. These temperature values are linked to the heating powers of Figure 11 by the following equation:

$$\dot{Q}_{th} = \dot{m} C_p (T_{in} - T_{out}) \quad (1)$$

where \dot{Q}_{th} , \dot{m} , C_p , T_{in} , T_{out} are injected thermal power, mass fluid flow rate, mass heat capacity ($C_p=3700$ J/kg K for the mono-propylene glycol – water mixture), temperature at the inlet of the ground heat exchanger, temperature at the outlet of the ground heat exchanger, respectively.

According to equation (1), the difference must be constant because the regulation loops fix the values of heating power and mass flow. It is clearly visible in Figure 12 that this difference remains constant.

In Figure 12, the temperature values of the “lawn” area are slightly higher than those of the “car-park” area. This difference is probably due to the fact that the soil is more compact in the car park and consequently, not so well heated by the spring air temperatures. The humidity profiles have also probably a non negligible effect on these temperatures.

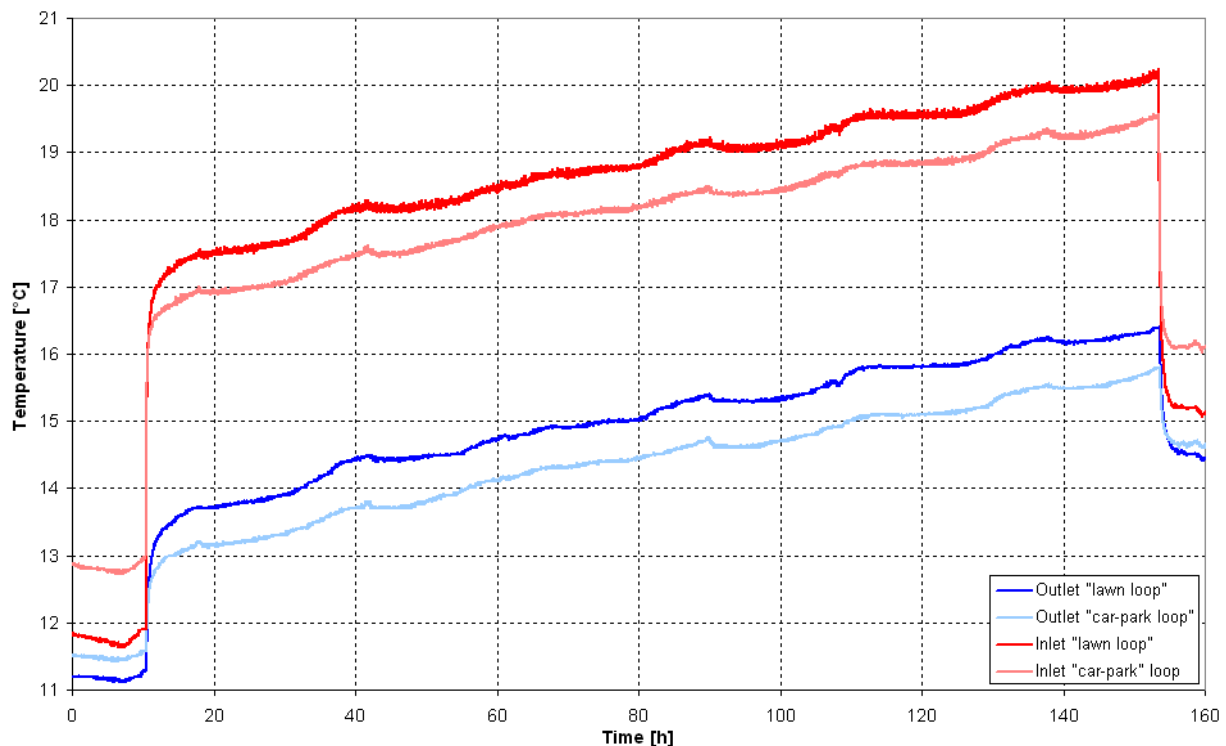

Figure 12: Evolution of the temperatures at the inlets and outlets of ground heat exchangers

3. SOIL TEMPERATURE MEASUREMENTS AND INTERPRETATIONS

The temperature in the soil is measured by optical fibers at three levels:

- along the heat exchanger tube at 1 m depth
- 0.5 m above the heat exchanger tube, following the same path than the tube
- 0.5 m below the heat exchanger tube, following the same path than the tube

Figure 13 presents the temperature measurement in the underground at these three levels in the “shaded lawn” sector.

The temperature measurements are represented at different times during the tests. The curves at 1 m depths show the

The porosity of the compact soil (“car-park” soil) is different than this of the “lawn” soil. Consequently the humidity transfer is different and the heat transfer conditions are different. In the future it is planned to measure in this test facility the underground humidity field to understand more precisely this phenomenon.

It is also interesting to notice that the heating of the soil after 6 days is transient, the slope of the temperature curves remains constant during the tests.

Besides, it is noticeable that the outside air temperature (see Figure 9) has a very slight short term effect on the evolution of the inlet and outlet temperatures for these ground heat exchangers buried at 1 m depth. Only little diurnal temperature waves are discernable.

evolution in the soil surrounding the heat exchanger tubes from undisturbed state to upper decreasing temperature profiles along the path of the fluid in the soil. As the fluid gives heat to the soil, its temperature goes down.

Besides, it is interesting to observe the evolution of the soil temperature above and below the heat exchanger tubes. The “deep” soil (1.5 m deep) acts as a thermal sink whose the temperature varies slightly although the upper soil layer (0.5 m deep) has a big increase of its temperature because the surface temperature is relatively high (about 20 °C on average, see in Figure 9).

Four little waves are also visible in the curves at 0.5 m deep, it corresponds to parts of the four loops which are more in the shadow than the rest of the ground heat exchanger surface.

The other soil temperature curves are given in Appendix A.

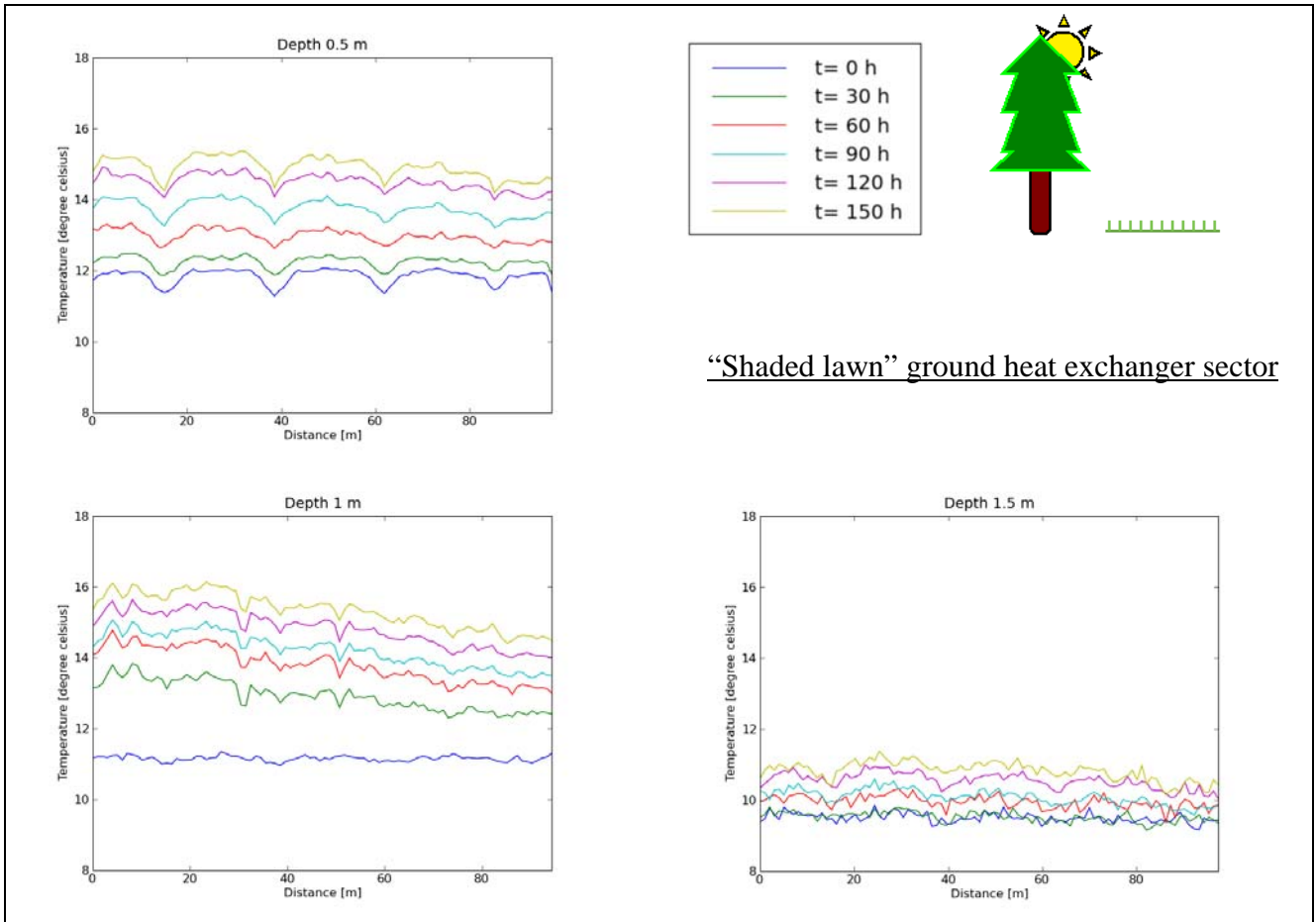

Figure 13: Evolution of the soil temperature at the three depth levels in the “shaded lawn” sector

4. CONCLUSION

In this article, a new test facility of ground heat exchangers implemented in France has been presented. This test facility aims to improve the knowledge of the ground heat exchangers for residential heating applications.

Some innovative features have been installed in this test facility to better know the evolution of the soil properties during an injection of heat or cold in the soil by different types of ground heat exchangers. First results of tests have been presented in this paper and seem to be quite coherent.

The temperature sensors let already us to see the effect of different surfacing (more or less compact soil) and

exposition conditions (shadow or sunny exposition) to the heat exchanges in the underground.

It is also planned to implement in this test facility a system of three dimensional measurement of the humidity level in the underground to better evaluate the effect of penetration of water in the ground on the performances of shallow ground heat exchangers, the thermal properties of the soil (thermal conductivity and diffusivity) depending strongly on the humidity level of the considered sample.

APPENDIX A: SOIL TEMPERATURE MEASUREMENTS IN THE TEST FACILITY

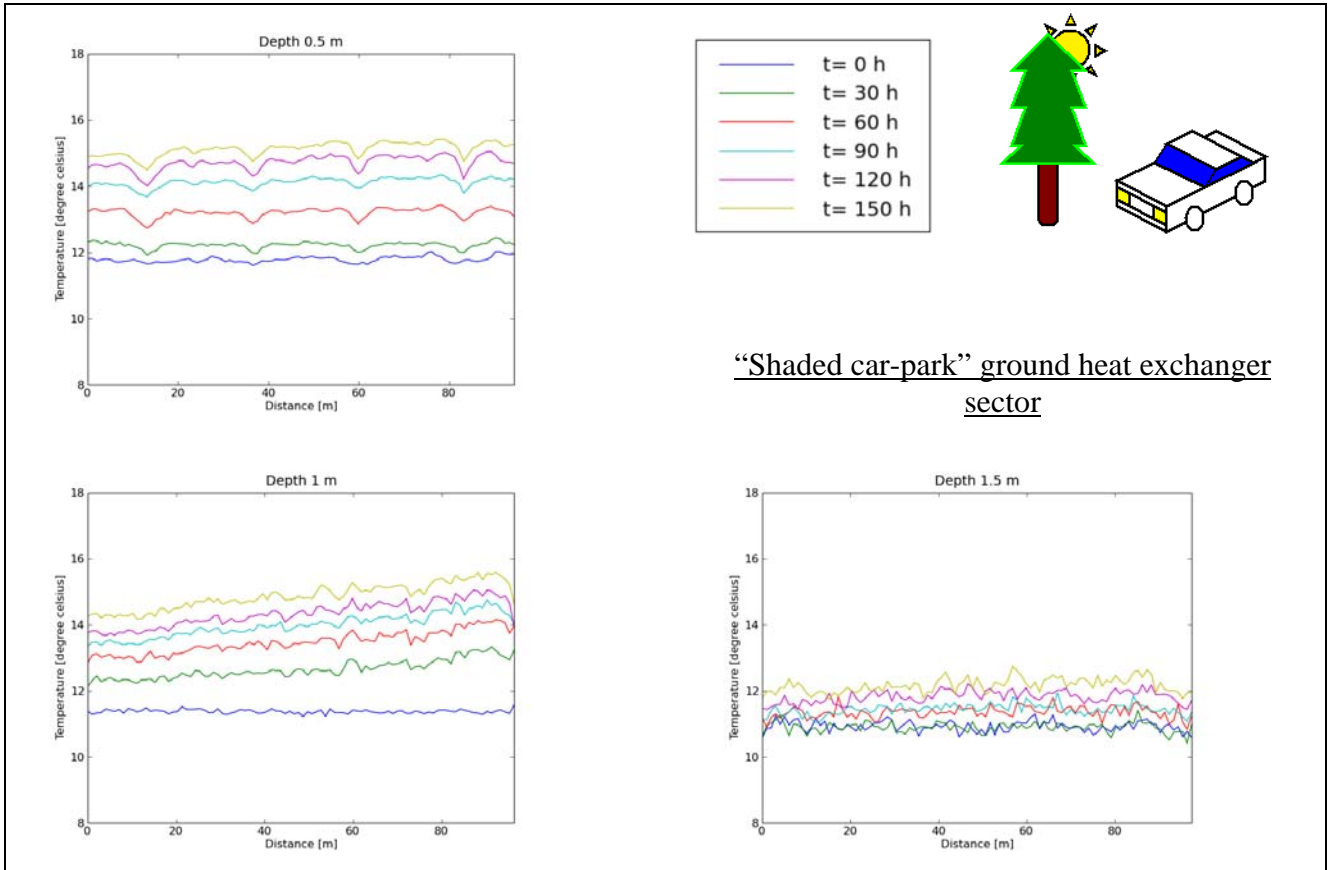

Figure 14: Evolution of the soil temperature at the three depth levels in the “shaded car-park” sector

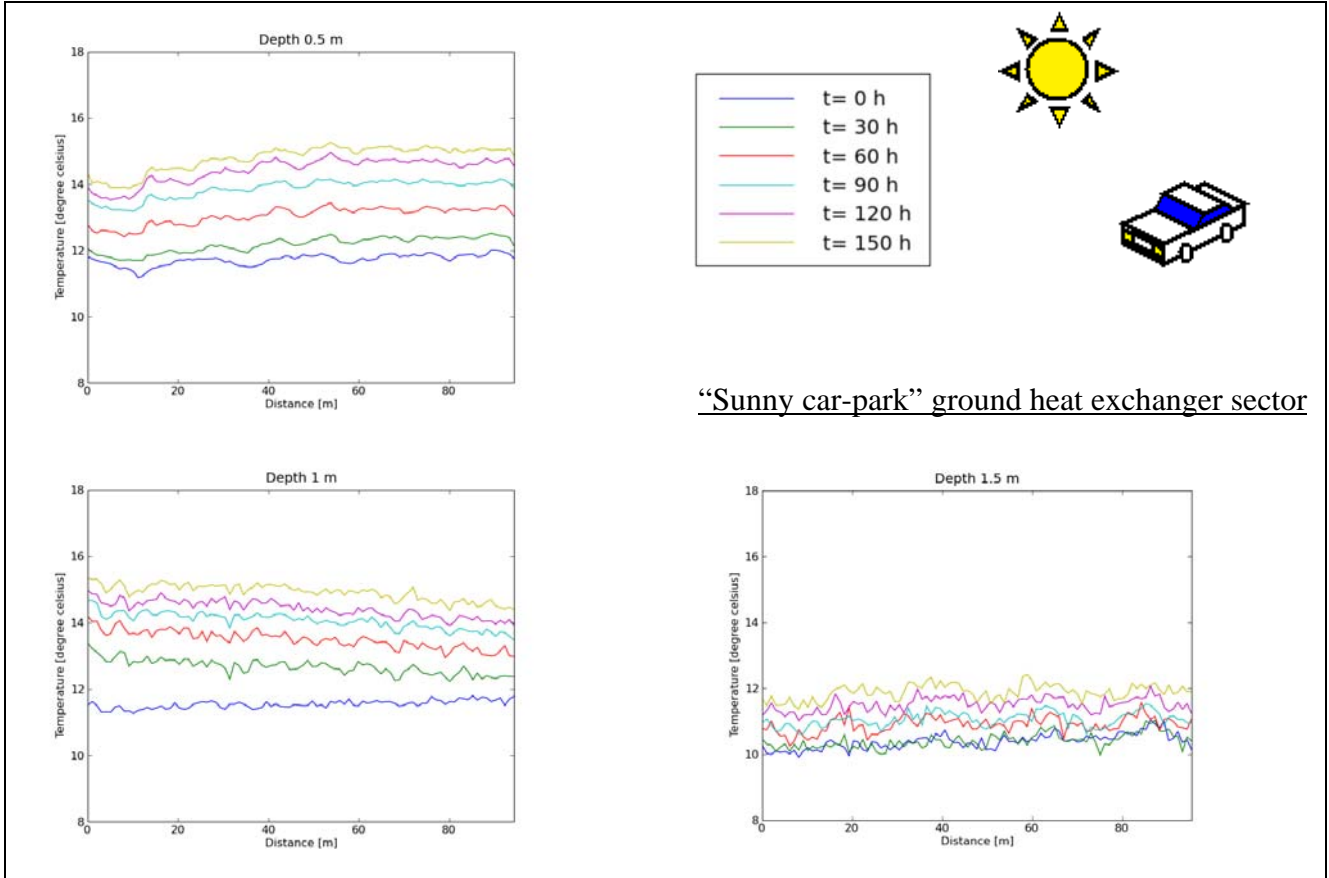

Figure 15: Evolution of the soil temperature at the three depth levels in the “sunny car-park” sector

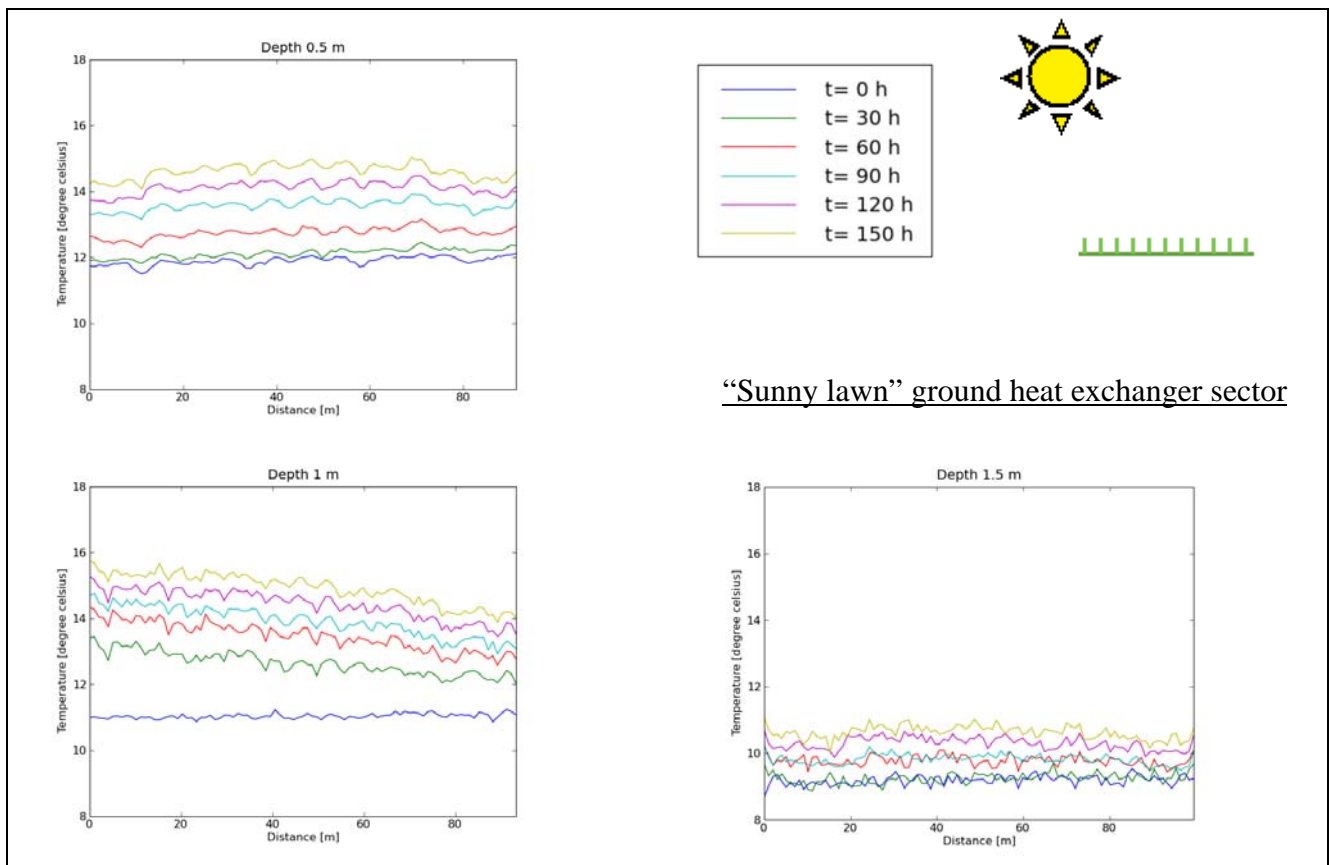

Figure 16: Evolution of the soil temperature at the three depth levels in the “sunny lawn” sector

REFERENCES

- Gehlin, S.: Thermal Response Test – Method Development and Evaluation, *Ph.D Thesis*, Department of Environmental Engineering, Lulea University of Technology, Sweden (2002).
- Hellström, G.: Borehole heat exchangers and thermal response test methods, *Proceedings*, 3rd Workshop of IEA HP annex 29, Sapporo, Japan (2006).
- Inalli, M., Esen, H.: Experimental thermal performance evaluation of a horizontal ground-source heat pump system, *Applied thermal engineering* (2004).
- Esen, H., Inalli, M., Esen, M.: Numerical and experimental analysis of a horizontal ground-coupled heat pump system, *Building and environment* (2007).
- Piechowski, M.: Heat and mass transfer model of a ground heat exchanger: validation and sensitivity analysis, *International journal of energy research* (1998).
- Fujii, H., et al., An improved thermal response test for U-tube ground heat exchanger based on optical fiber thermometers. *Geothermics* (2009)
- Verein Deutscher Ingenieure: Guideline VDI 4640 “Thermal Use of the Underground”, September 2001